

FläktGroup[®]

AIRTREND Ltd.
Predstavništvo u Beogradu
Kumanovska 14
11000 Beograd
Tel: 011 3836886, 3085740
Faks: 011 3444113
e-mail: gobrid@eunet.rs
web: www.airtrend.rs

Plenum box TG / TGE

TECHNICAL DATA



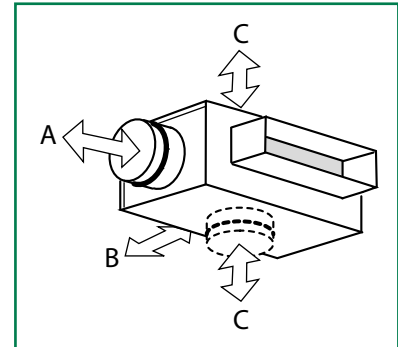
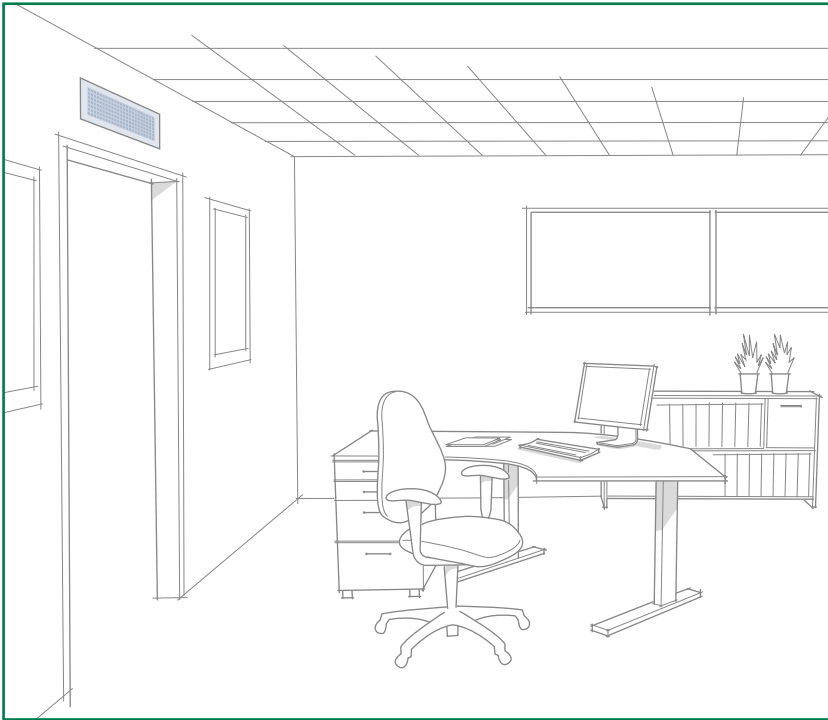

Plenum boxes TG (supply air) and TGE (exhaust air) are intended for use with rectangular grilles and have a circular duct connection. They have a low sound level and a good sound attenuation capacity. The plenum box can be connected from the side, the top or the back. The TG includes an easily removable balancing plate which gives a uniform air flow to the grilles. The patented measurement and adjustment damper enables balanced and accurate values.

QUICK SELECTION

TG plenum box with rear connection (B), fully open

Size TG-	Duct connection, mm	Air flow l/s (m ³ /h) at sound level		
		25 dB(A)	30 dB(A)	35 dB(A)
200-100	125	28	34	41
300-100	160	46	56	66
400-100	160	51	61	74
500-100	200	72	85	105
600-100	250	100	122	145
1000-100	250	200	235	270
300-150	200	61	73	90
400-150	250	90	108	130
500-150	250	102	122	145
600-150	250	98	118	142
800-150	315	184	220	255
400-200	250	100	122	146
500-200	315	152	162	215
600-200	315	180	215	250
800-200	315	181	220	260
1000-200	315	210	250	300

SPECIFICATIONS

- Low sound level
- Easy to install and adjust
- Uniform air flow to grille
- Accurate air flow measurement and adjustment
- Includes a ZAEF measurement and adjustment damper that can be easily removed without changing the setting
- Made of galvanized steel sheet
- Tightness class C

PRODUCT CODE EXAMPLE

Plenum box **TG-300-100-A**
(supply air)

Plenum box **TGE-300-100-A**
(exhaust air)

TG SUPPLY AIR - AIR FLOW, PRESSURE DROP, SOUND LEVEL

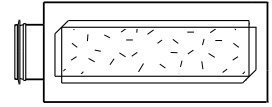

A - CONNECTION FROM THE SIDE

TG-200-100-A (Ø125)

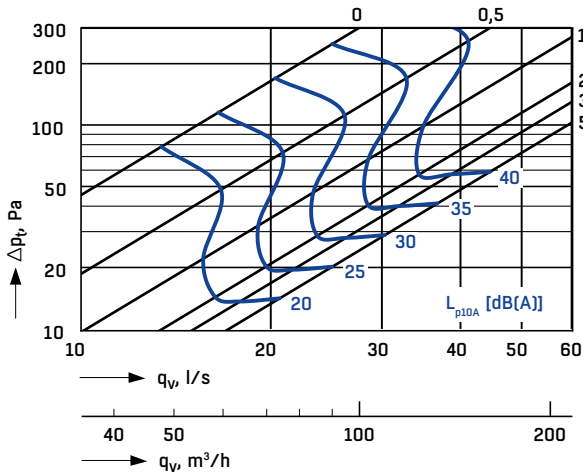

TG-300-100-A (Ø160)

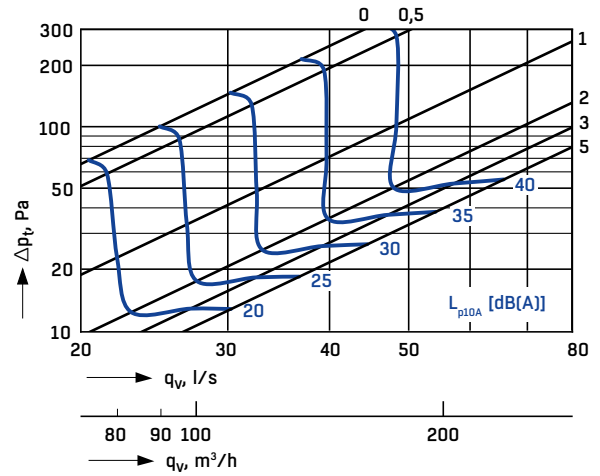

TG-400-100-A (Ø160)

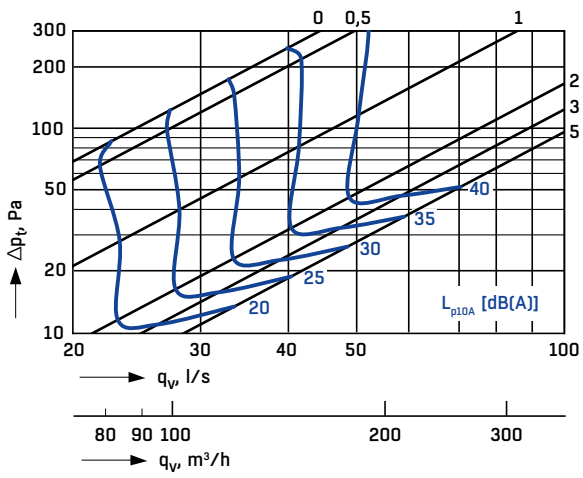

TG-500-100-A (Ø200)

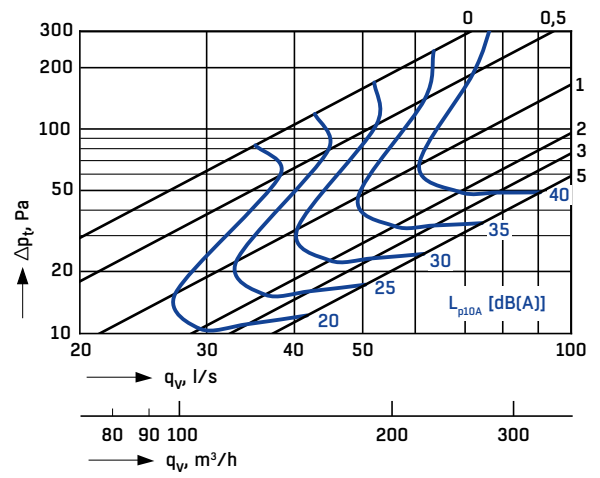

TG-600-100-A (Ø250)

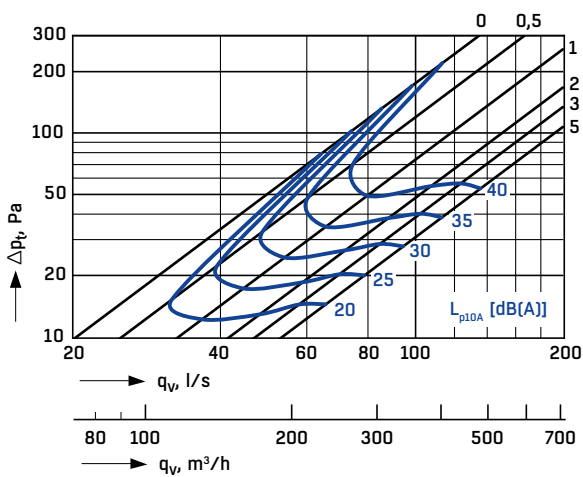

TG-1000-100-A (Ø250)

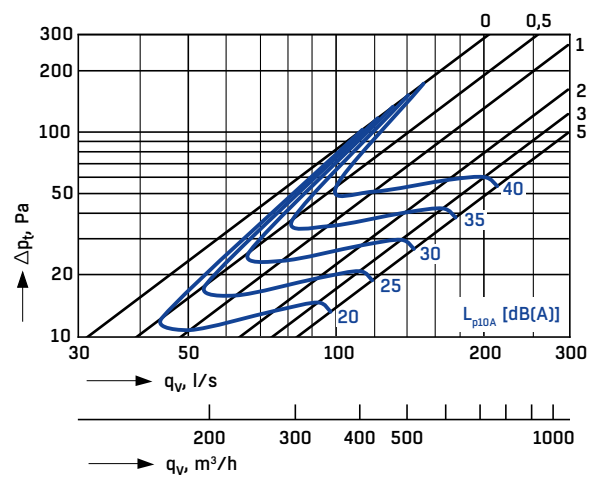

TG SUPPLY AIR - AIR FLOW, PRESSURE DROP, SOUND LEVEL

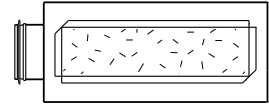

A - CONNECTION FROM THE SIDE

TG-300-150-A (Ø200)

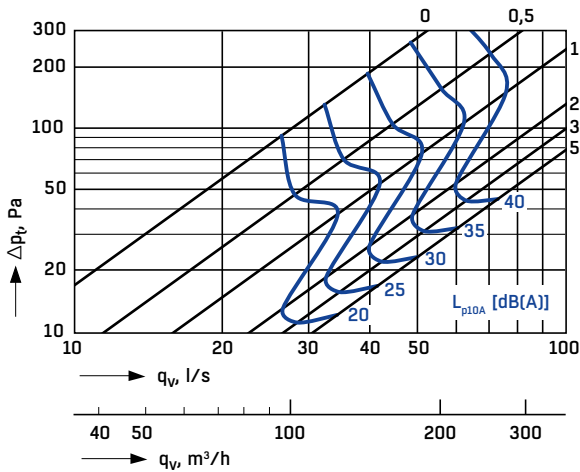

TG-400-150-A (Ø250)

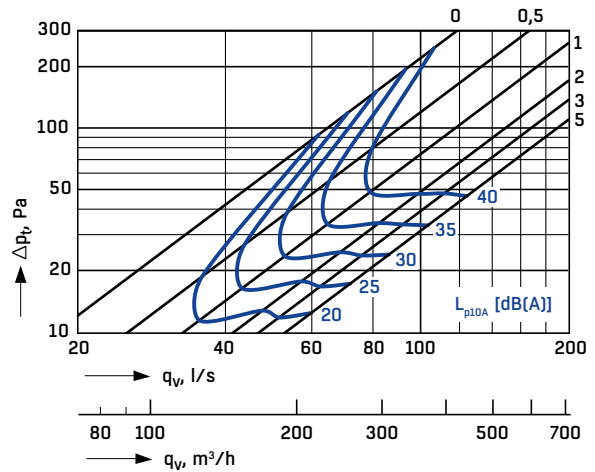

TG-500-150-A (Ø250)

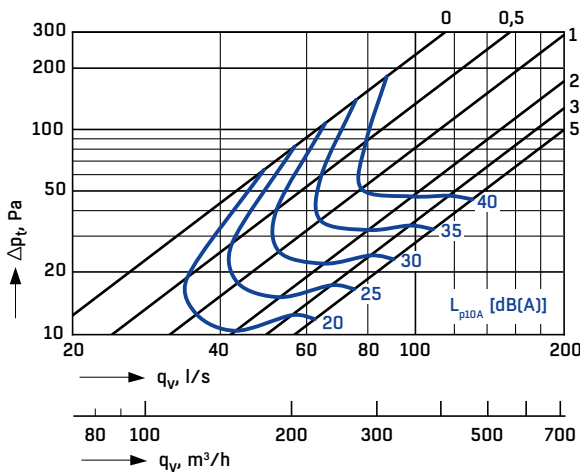

TG-600-150-A (Ø250)

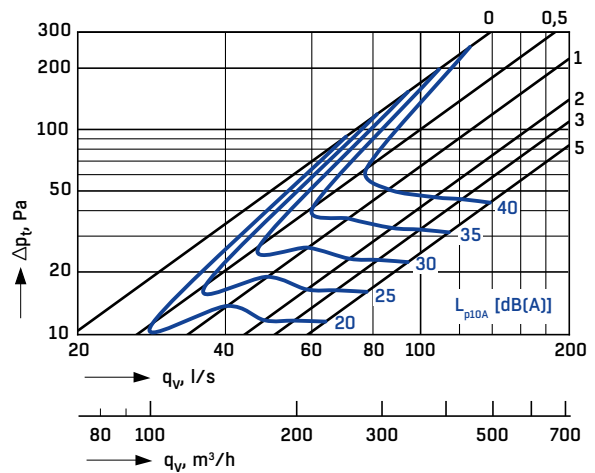

TG-800-150-A (Ø315)

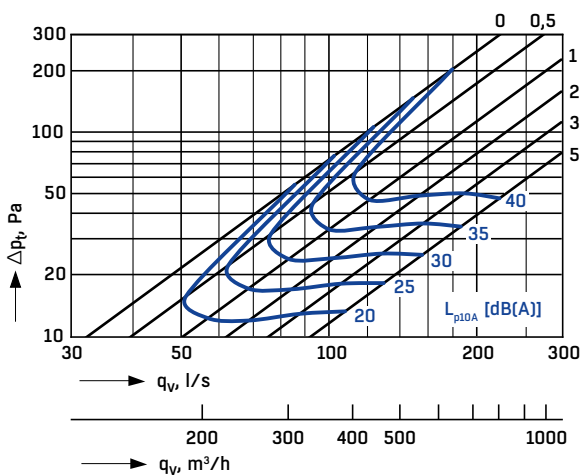

TG SUPPLY AIR - AIR FLOW, PRESSURE DROP, SOUND LEVEL

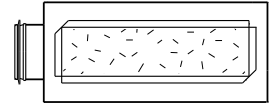

A - CONNECTION FROM THE SIDE

TG-400-200-A (Ø250)

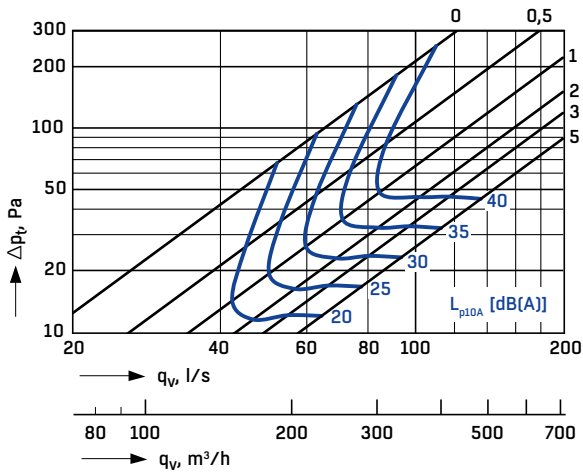

TG-500-200-A (Ø315)

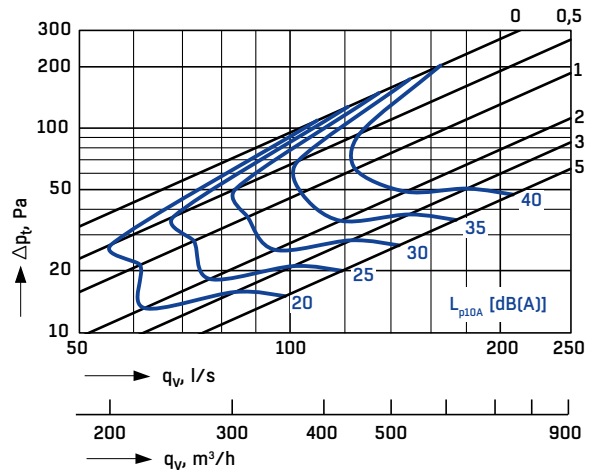

TG-600-200-A (Ø315)

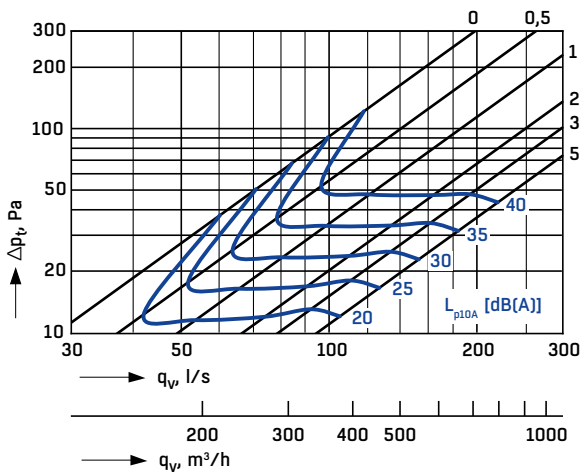

TG-800-200-A (Ø315)

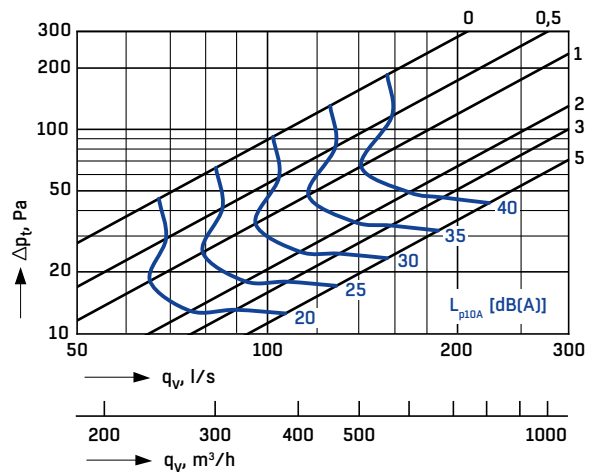

TG-1000-200-A (Ø315)

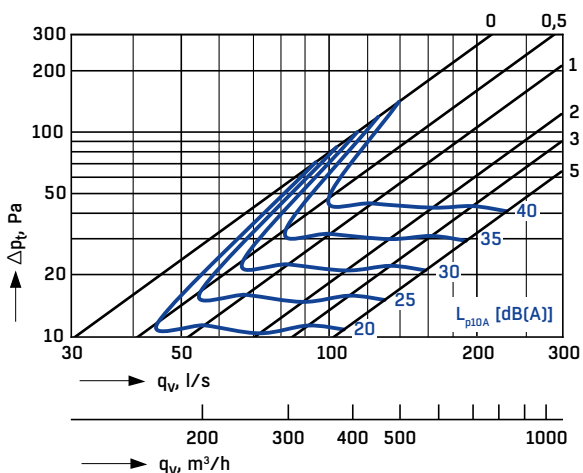

TG SUPPLY AIR - AIR FLOW, PRESSURE DROP, SOUND LEVEL

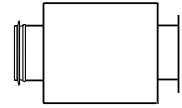

B - REAR CONNECTION

TG-200-100-B (Ø125)

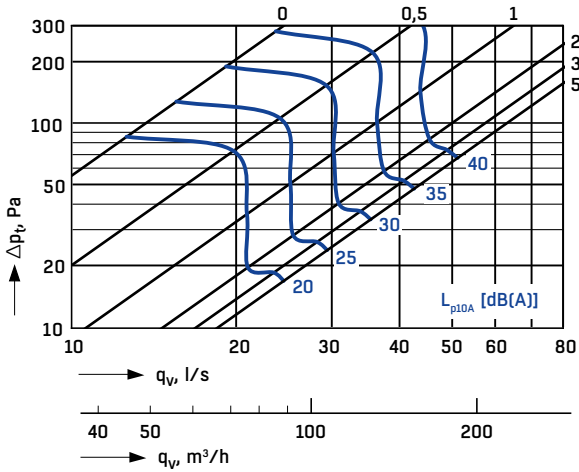

TG-300-100-B (Ø160)

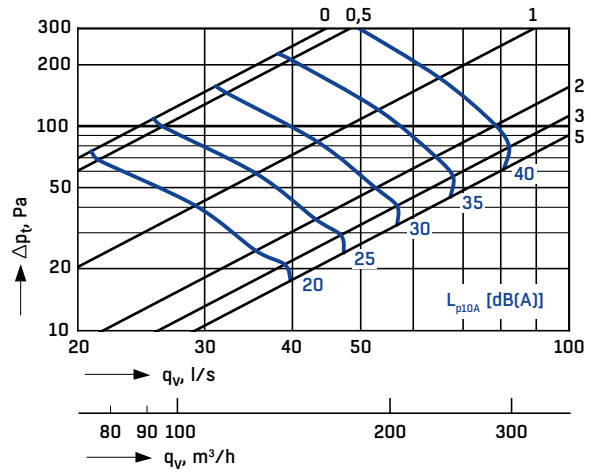

TG-400-100-B (Ø160)

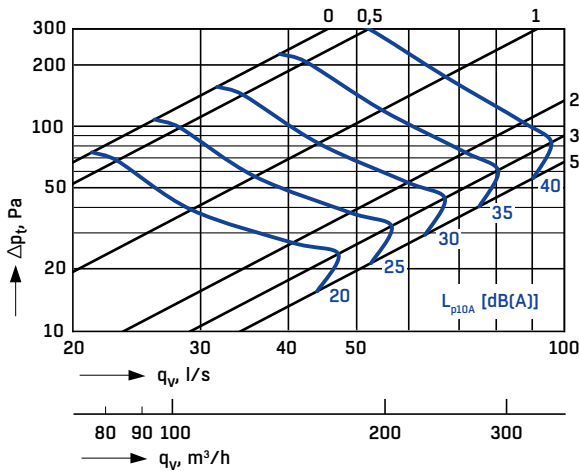

TG-500-100-B (Ø200)

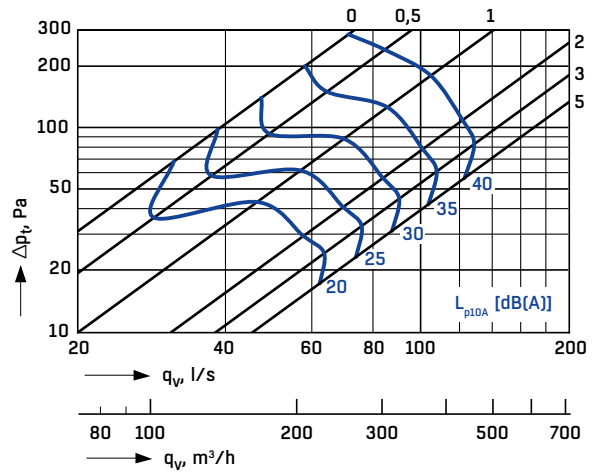

TG-600-100-B (Ø250)

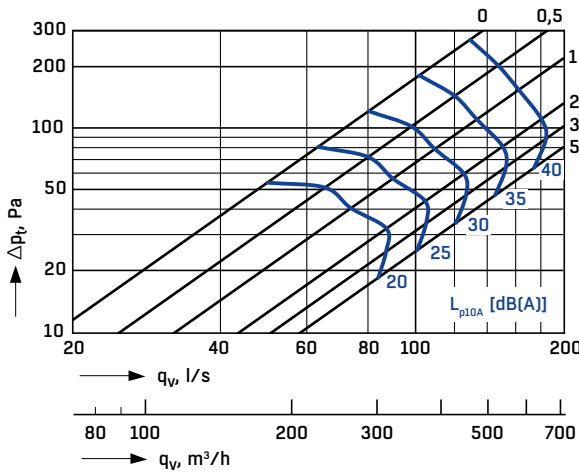

TG-1000-100-B (Ø250)

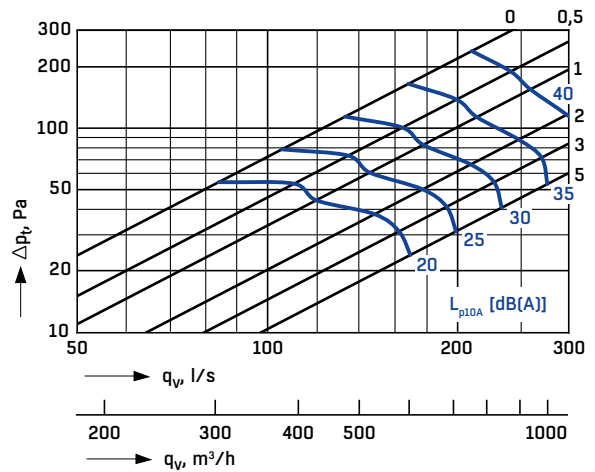

TG SUPPLY AIR - AIR FLOW, PRESSURE DROP, SOUND LEVEL

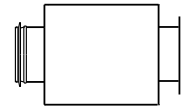

B - REAR CONNECTION

TG-300-150-B (Ø200)

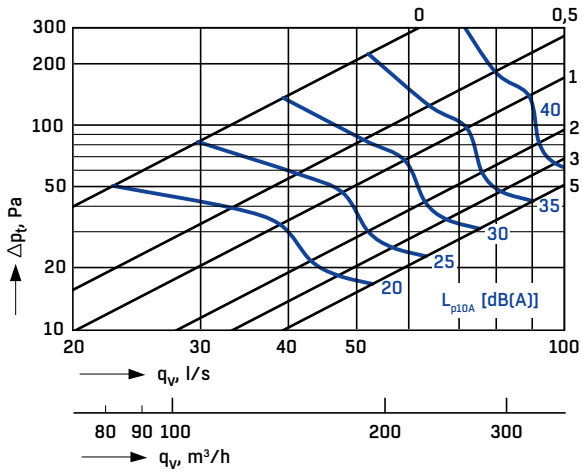

TG-400-150-B (Ø250)

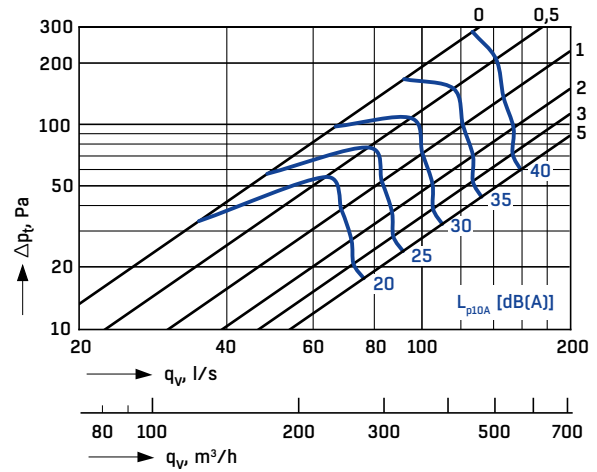

TG-500-150-B (Ø250)

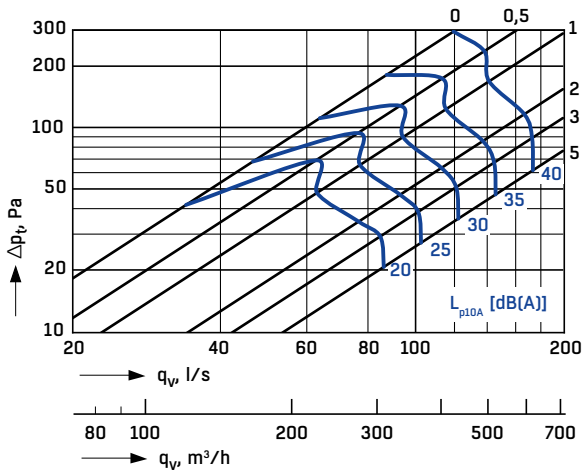

TG-600-150-B (Ø250)

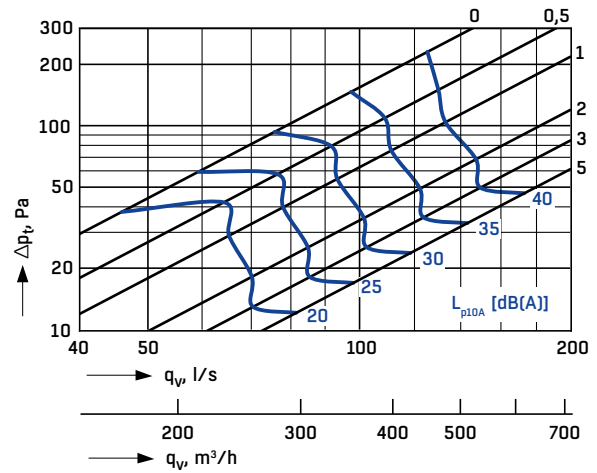

TG-800-150-B (Ø315)

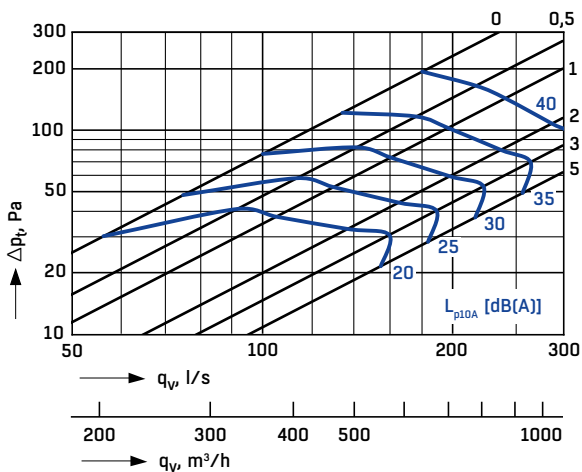

TG SUPPLY AIR - AIR FLOW, PRESSURE DROP, SOUND LEVEL

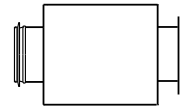

B - REAR CONNECTION

TG-400-200-B (Ø250)

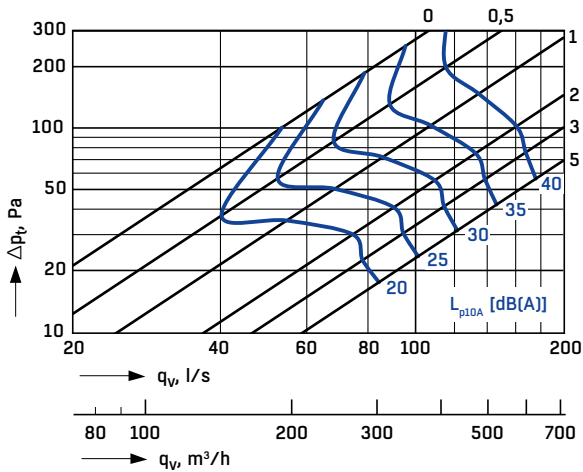

TG-500-200-B (Ø315)

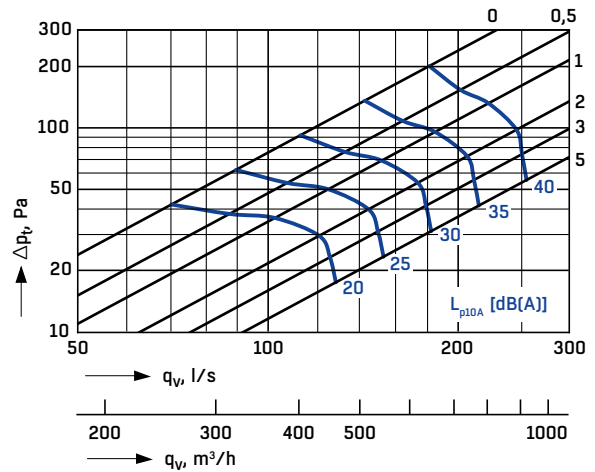

TG-600-200-B (Ø315)

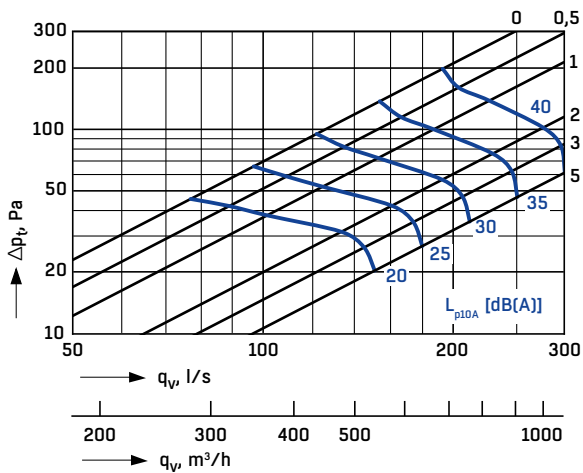

TG-800-200-B (Ø315)

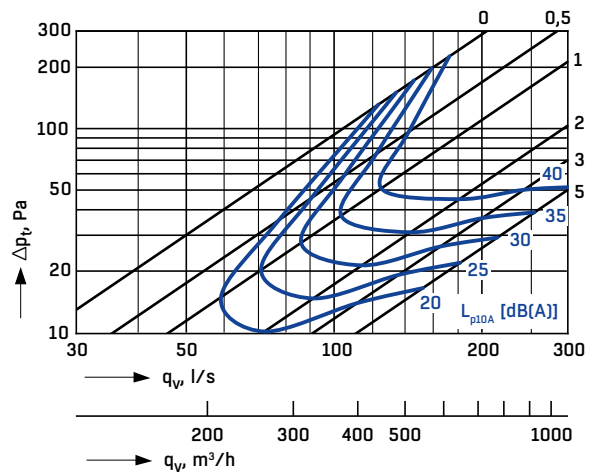

TG-1000-200-B (Ø315)

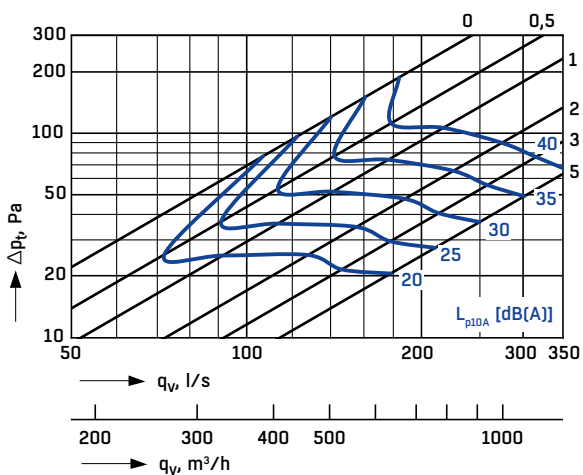

TG SUPPLY AIR - AIR FLOW, PRESSURE DROP, SOUND LEVEL

C - TOP/BOTTOM CONNECTION

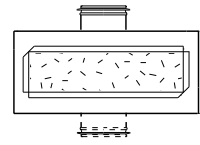

TG-200-100-C (Ø125)

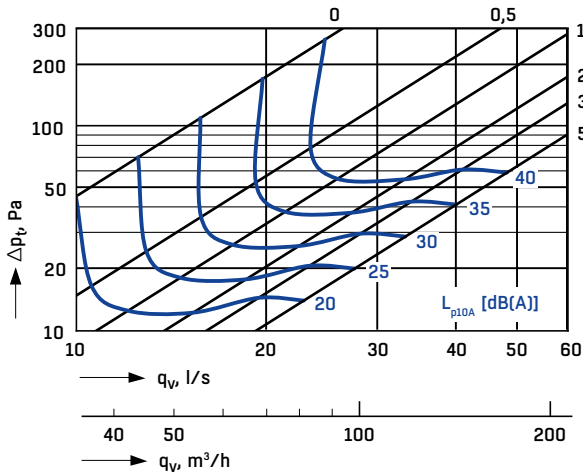

TG-300-100-C (Ø160)

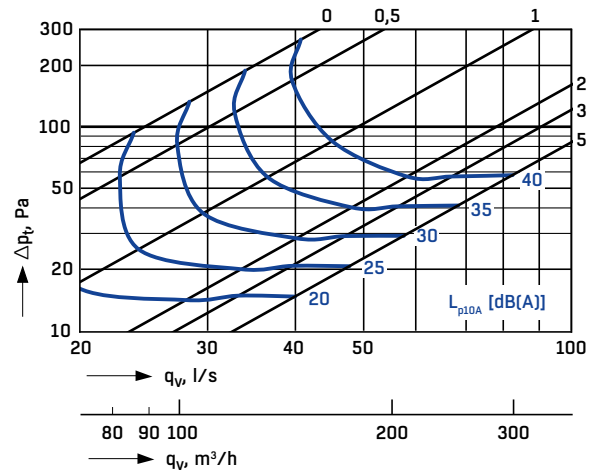

TG-400-100-C (Ø160)

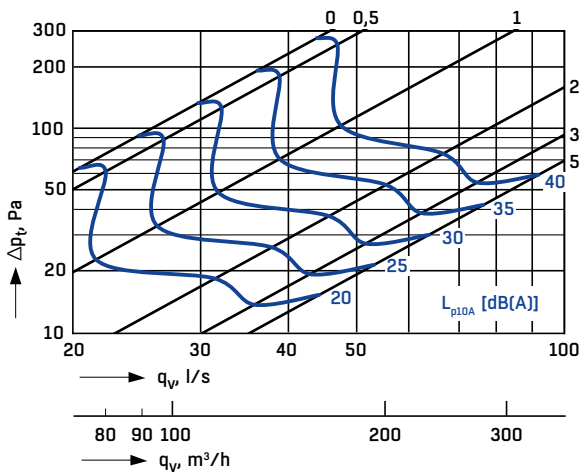

TG-500-100-C (Ø200)

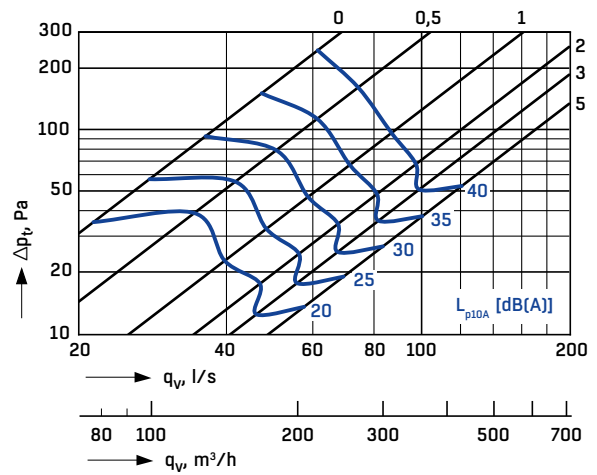

TG-600-100-C (Ø250)

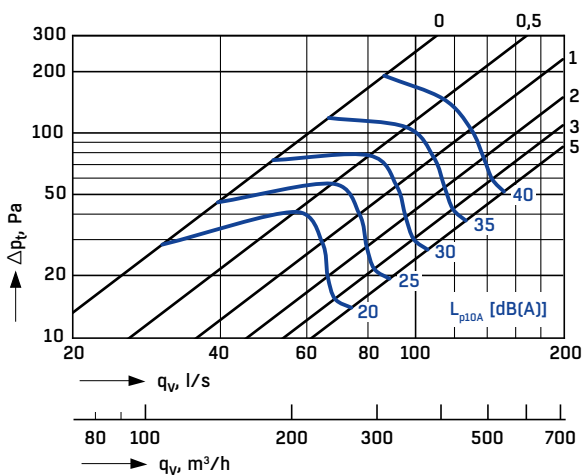

TG-1000-100-C (Ø250)

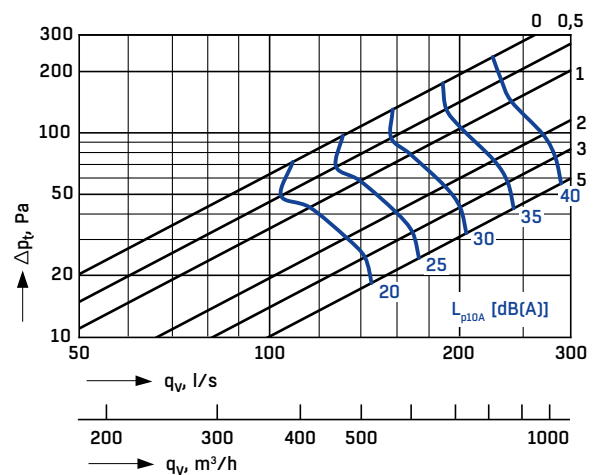

TG SUPPLY AIR - AIR FLOW, PRESSURE DROP, SOUND LEVEL

C - TOP/BOTTOM CONNECTION

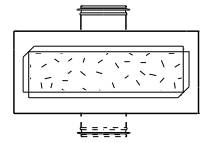

TG-300-150-C (Ø200)

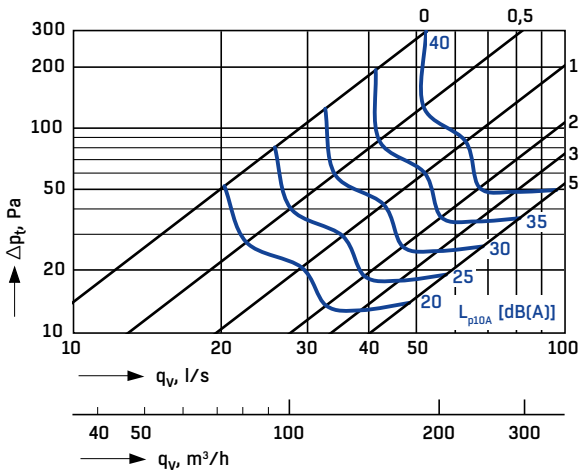

TG-400-150-C (Ø250)

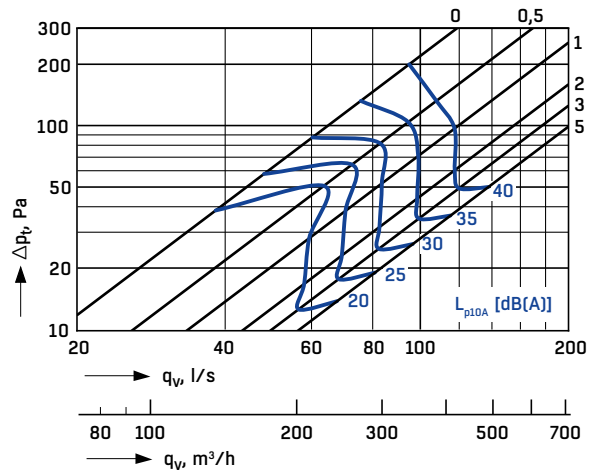

TG-500-150-C (Ø250)

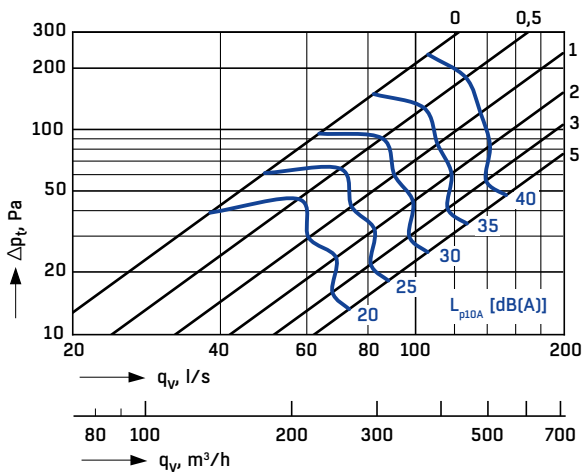

TG-600-150-C (Ø250)

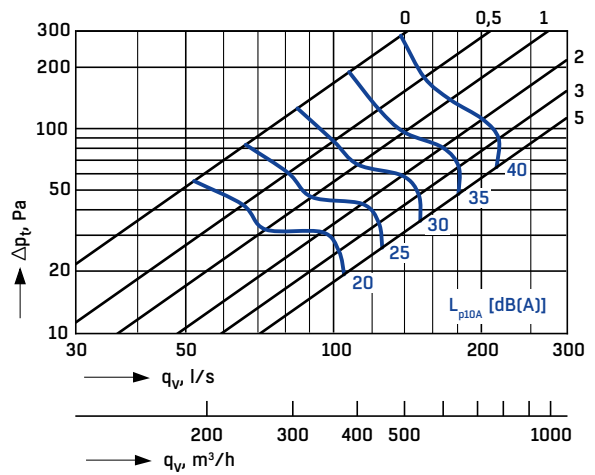

TG-800-150-C (Ø315)

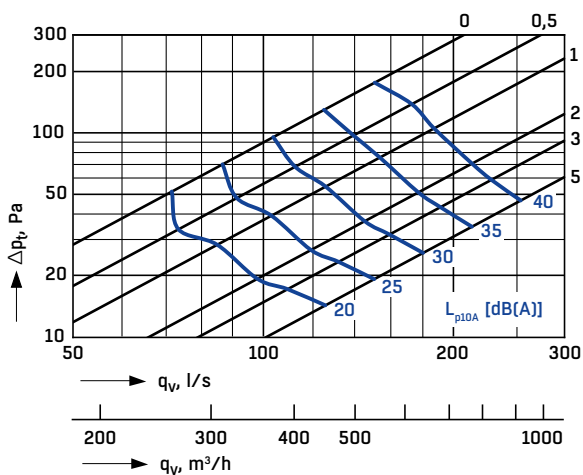

TG SUPPLY AIR - AIR FLOW, PRESSURE DROP, SOUND LEVEL

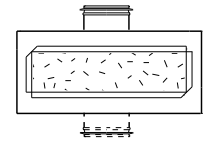

C - TOP/BOTTOM CONNECTION

TG-400-200-C (Ø250)

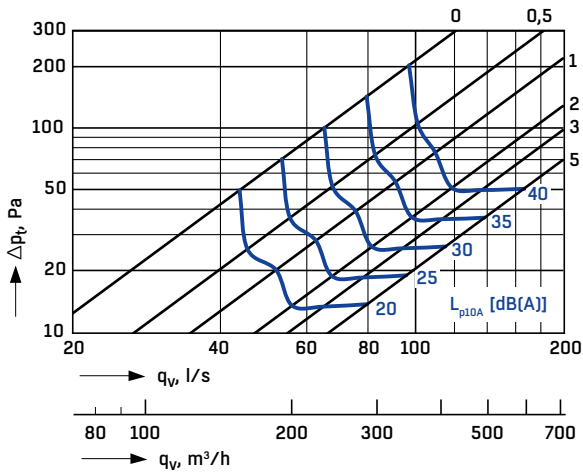

TG-500-200-C (Ø315)

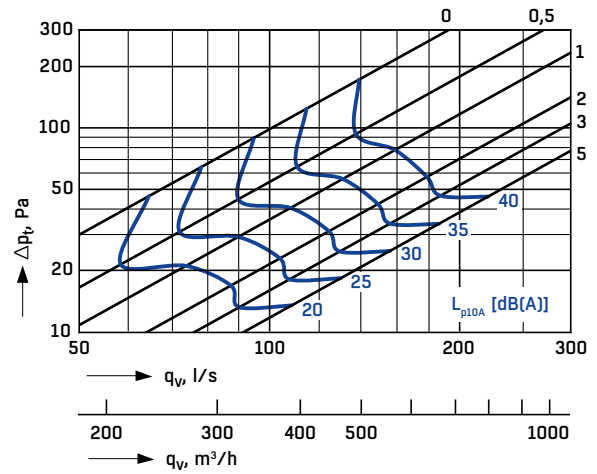

TG-600-200-C (Ø315)

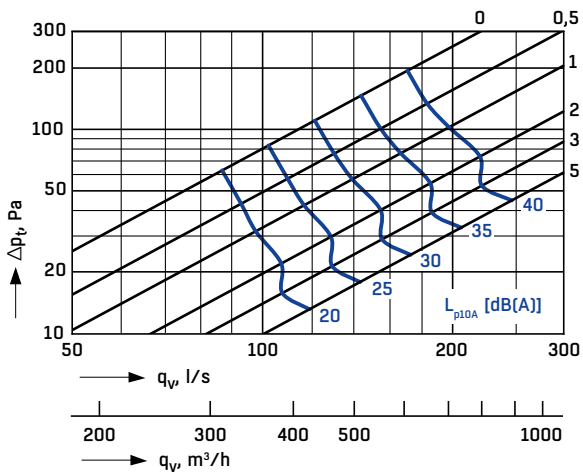

TG-800-200-C (Ø315)

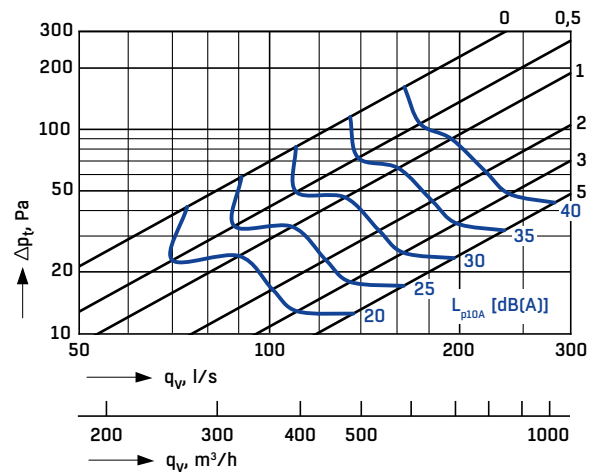

TG-1000-200-C (Ø315)

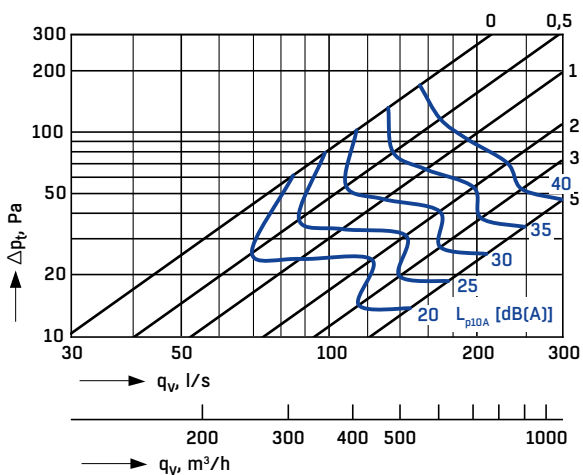

TGE EXHAUST AIR - AIR FLOW, PRESSURE DROP, SOUND LEVEL

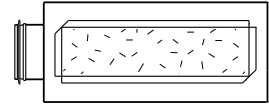

A - CONNECTION FROM THE SIDE

TGE-200-100-A (Ø125)

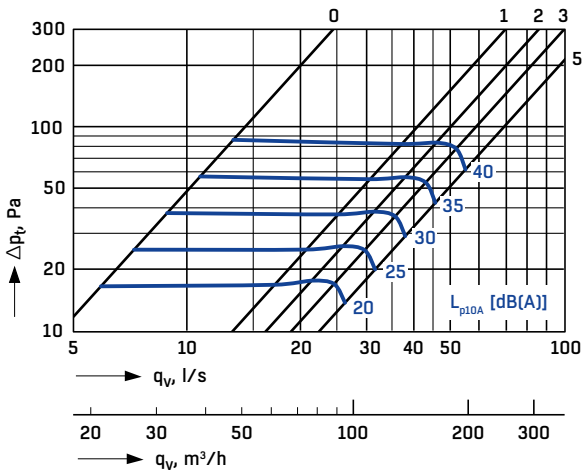

TGE-300-100-A (Ø160)

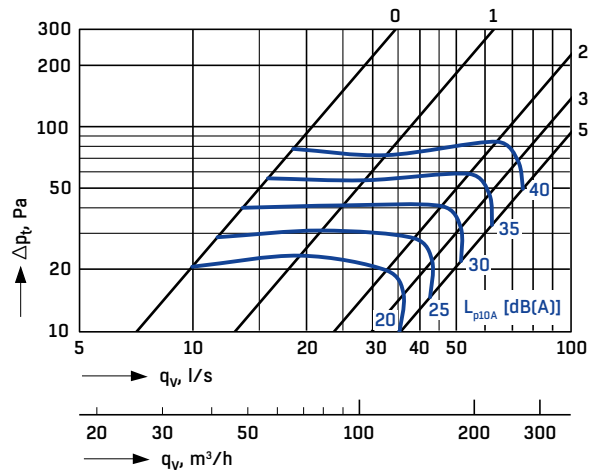

TGE-400-100-A (Ø160)

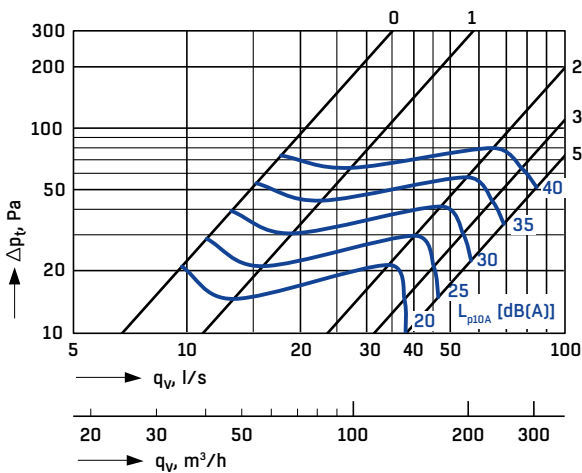

TGE-500-100-A (Ø200)

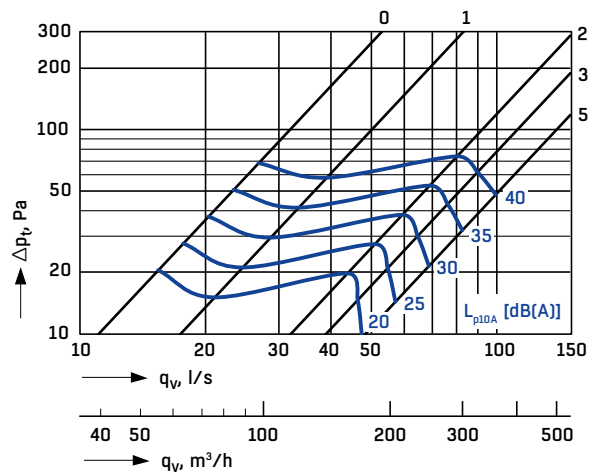

TGE-600-100-A (Ø250)

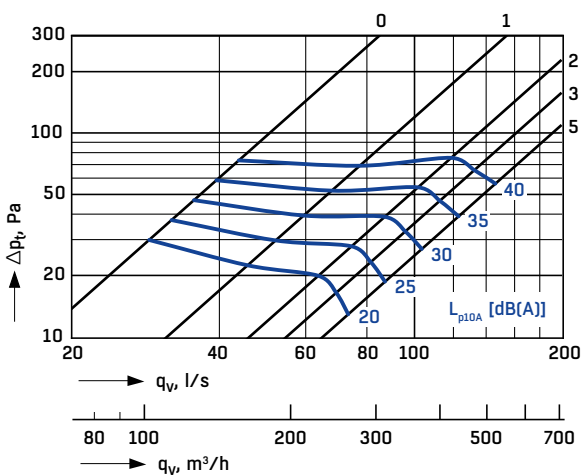

TGE-1000-100-A (Ø250)

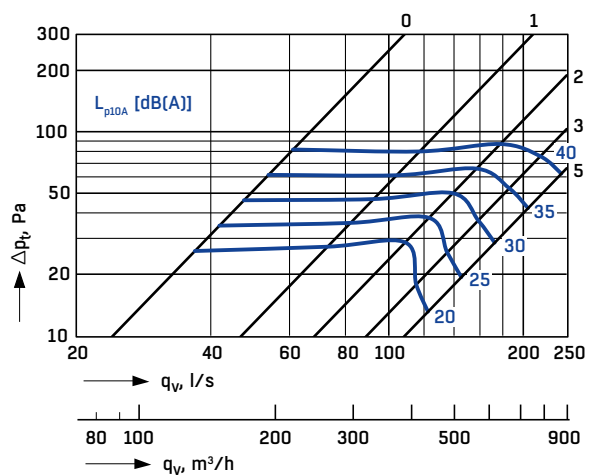

TGE EXHAUST AIR - AIR FLOW, PRESSURE DROP, SOUND LEVEL

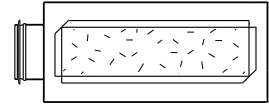

A - CONNECTION FROM THE SIDE

TGE-300-150-A (Ø200)

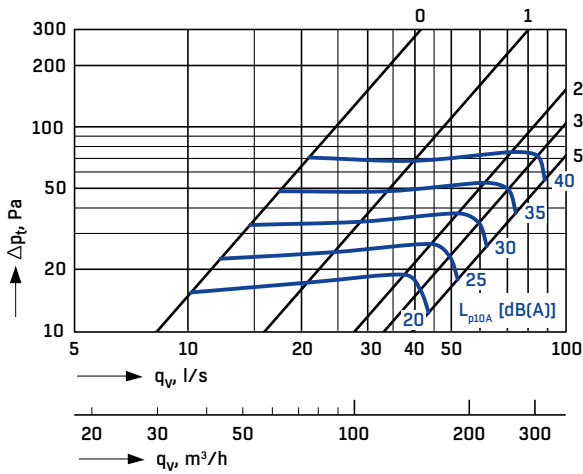

TGE-400-150-A (Ø250)

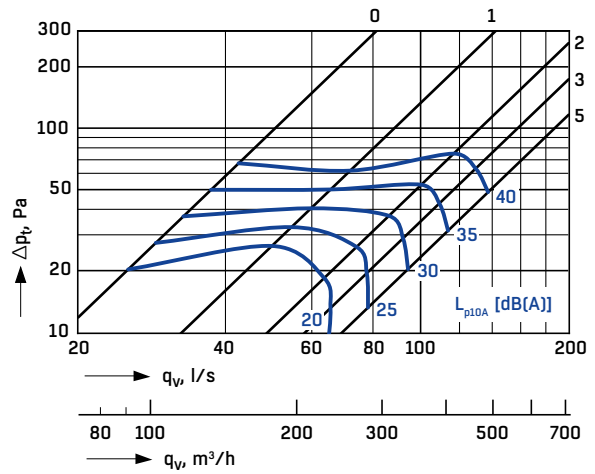

TGE-500-150-A (Ø250)

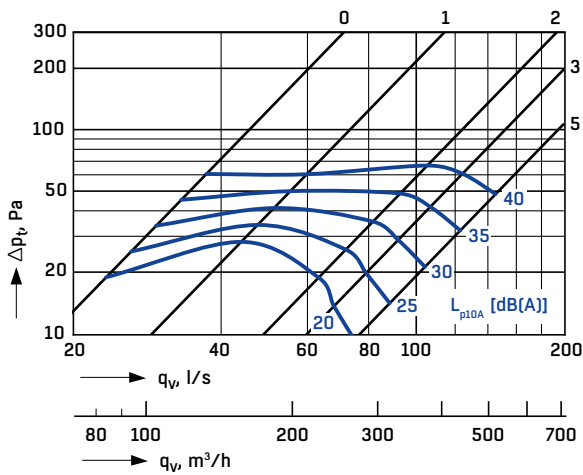

TGE-600-150-A (Ø250)

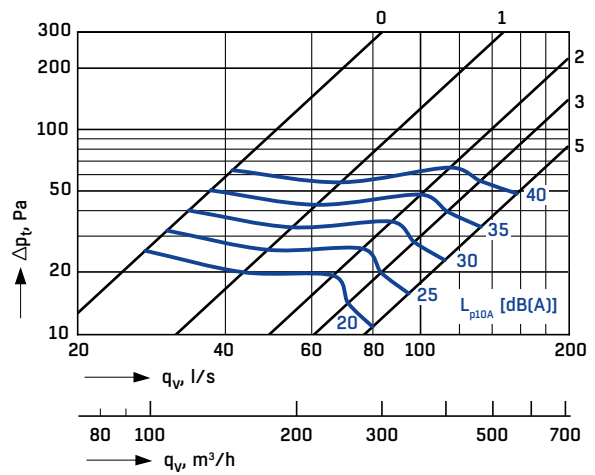

TGE-800-150-A (Ø315)

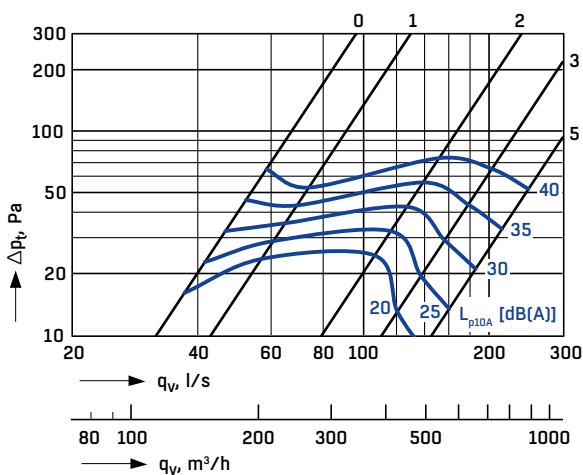

TGE EXHAUST AIR - AIR FLOW, PRESSURE DROP, SOUND LEVEL

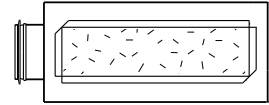

A - CONNECTION FROM THE SIDE

TGE-400-200-A (Ø250)

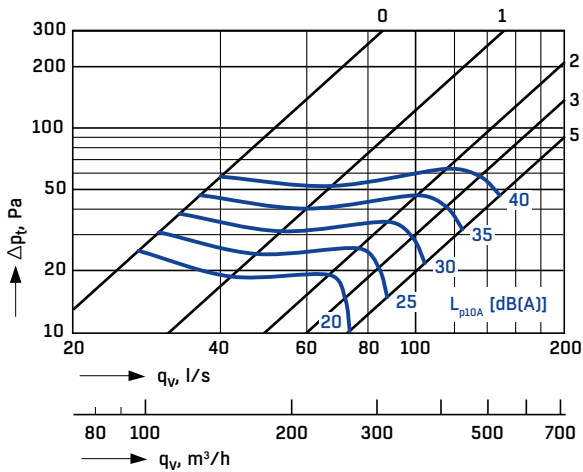

TGE-500-200-A (Ø315)

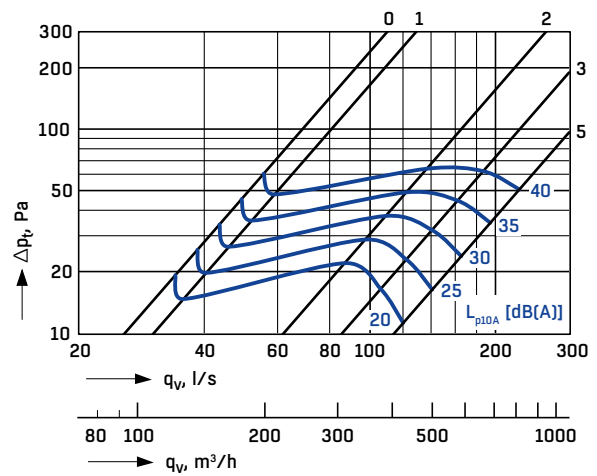

TGE-600-200-A (Ø315)

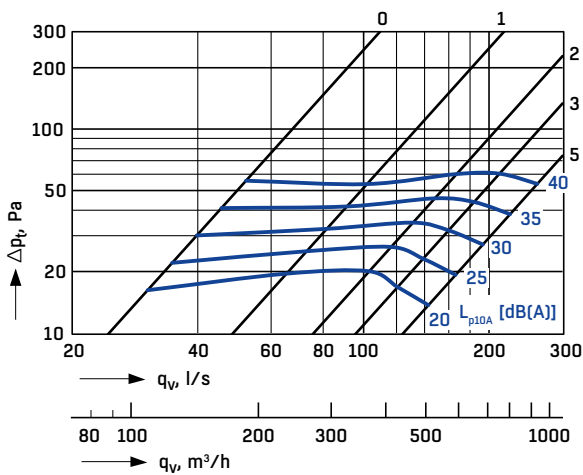

TGE-800-200-A (Ø315)

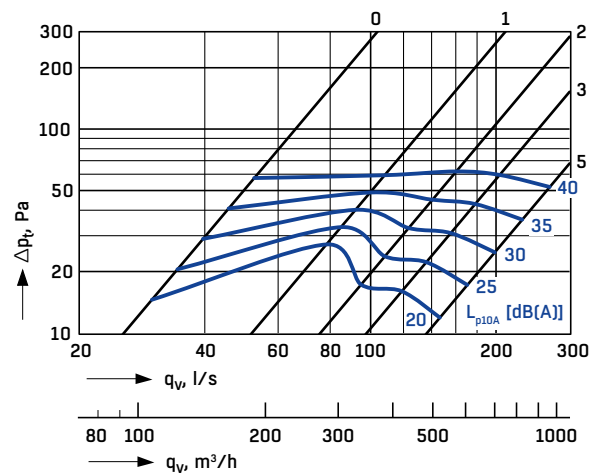

TGE-1000-200-A (Ø315)

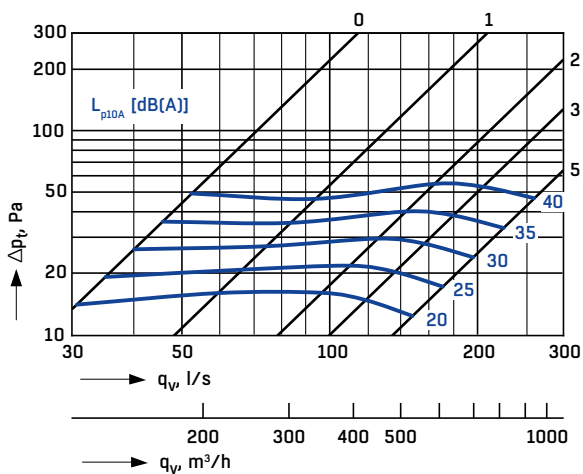

TGE EXHAUST AIR - AIR FLOW, PRESSURE DROP, SOUND LEVEL

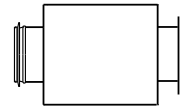

B - REAR CONNECTION

TGE-200-100-B (Ø125)

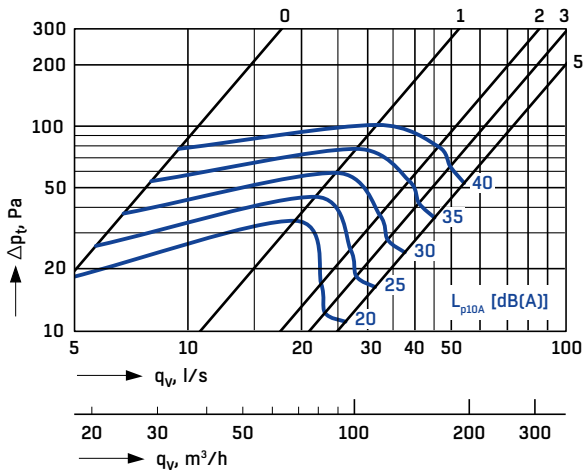

TGE-300-100-B (Ø160)

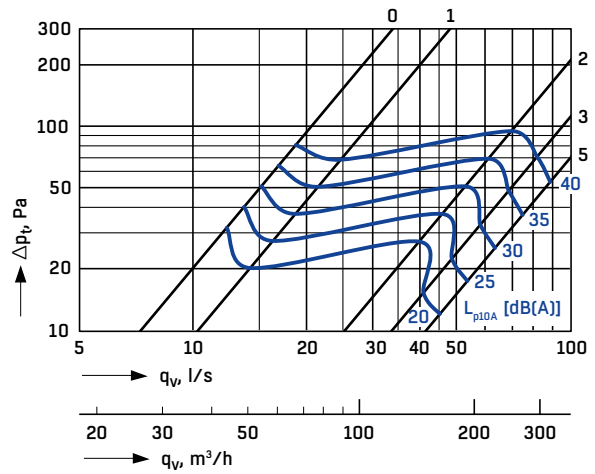

TGE-400-100-B (Ø160)

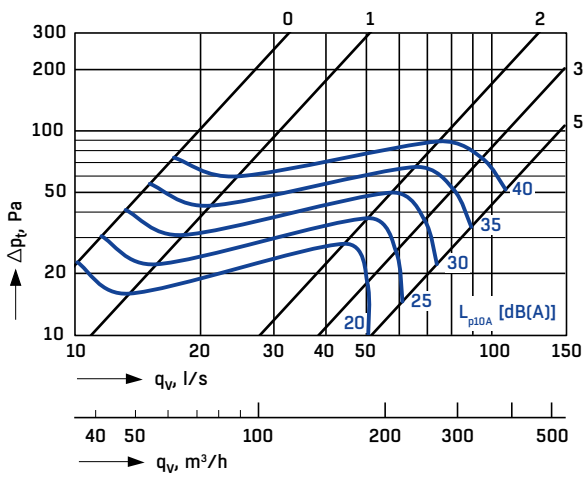

TGE-500-100-B (Ø200)

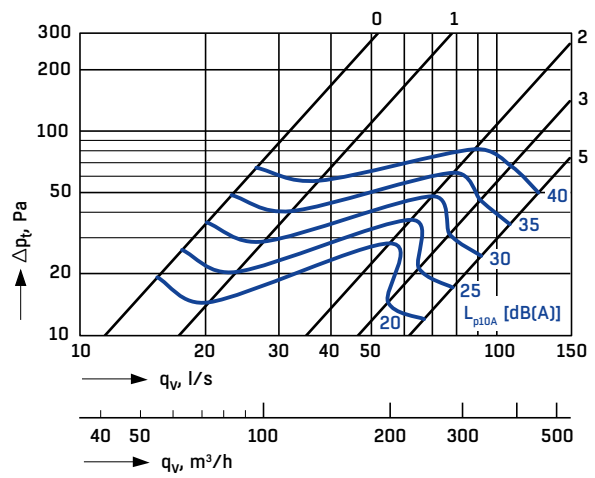

TGE-600-100-B (Ø250)

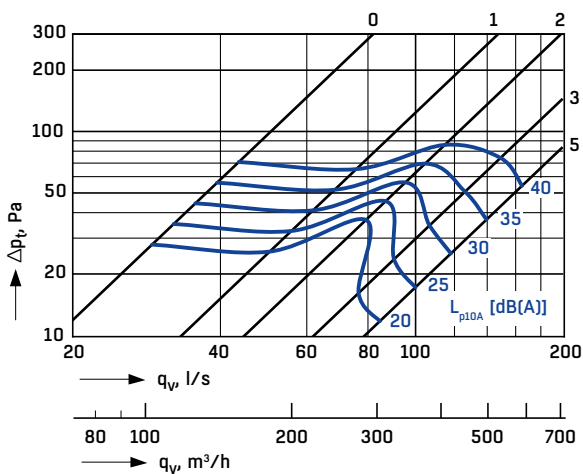

TGE-1000-100-B (Ø250)

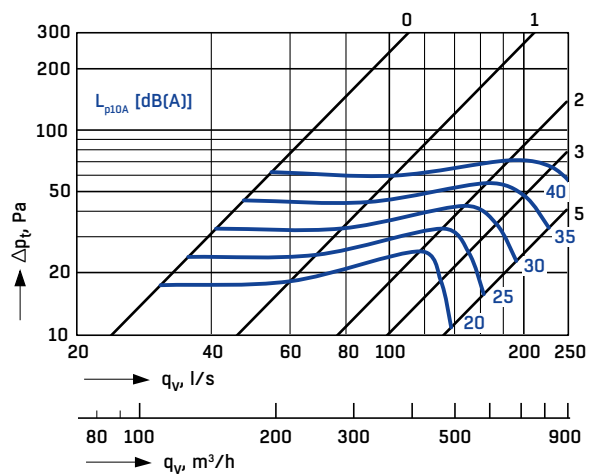

TGE EXHAUST AIR - AIR FLOW, PRESSURE DROP, SOUND LEVEL

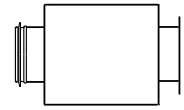

B - REAR CONNECTION

TGE-300-150-B (Ø200)

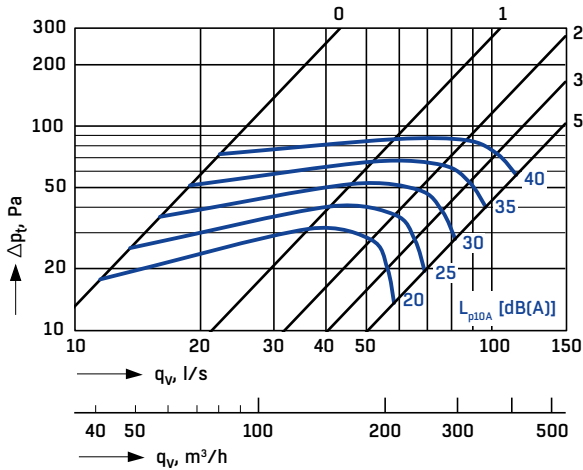

TGE-400-150-B (Ø250)

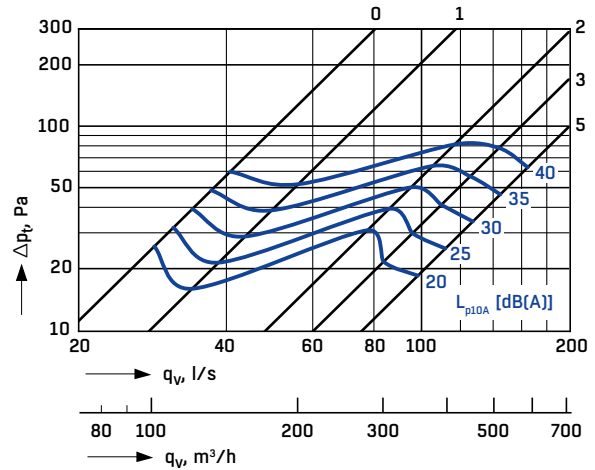

TGE-500-150-B (Ø250)

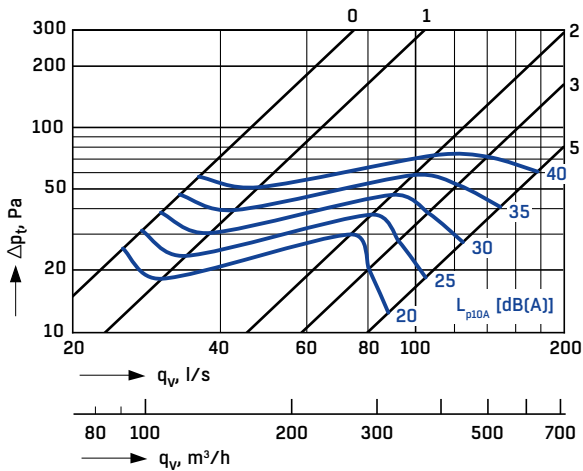

TGE-600-150-B (Ø250)

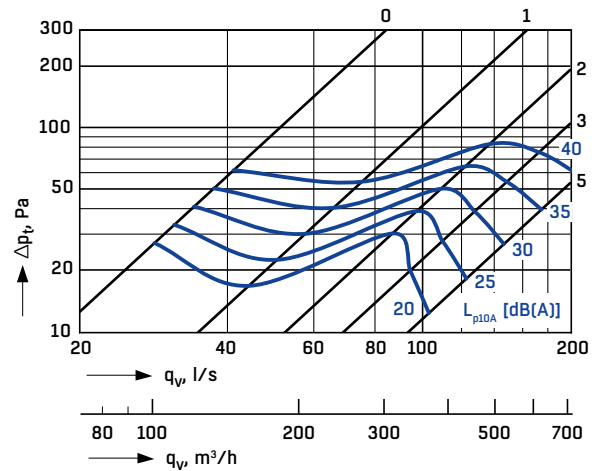

TGE-800-150-B (Ø315)

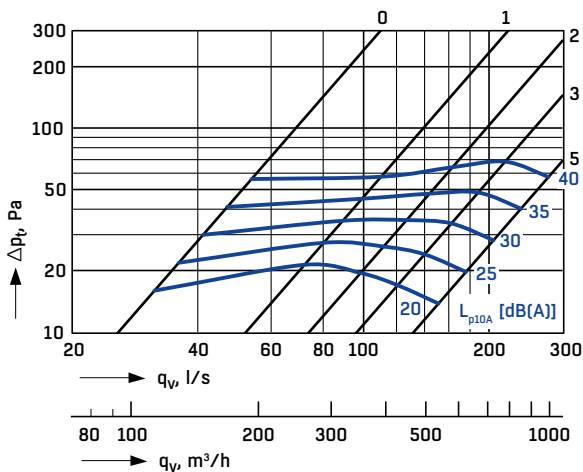

TGE EXHAUST AIR - AIR FLOW, PRESSURE DROP, SOUND LEVEL

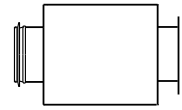

B - REAR CONNECTION

TGE-400-200-B (Ø250)

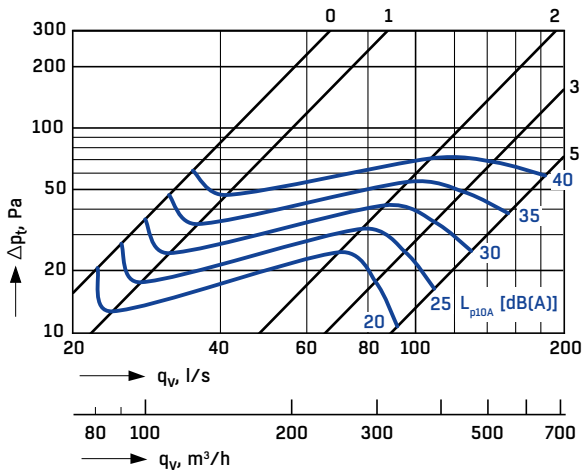

TGE-500-200-B (Ø315)

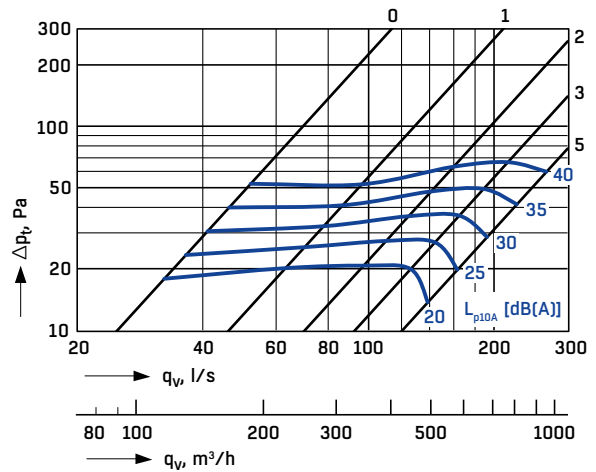

TGE-600-200-B (Ø315)

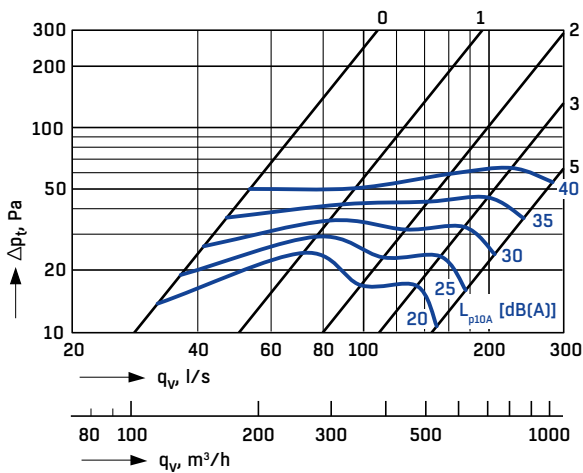

TGE-800-200-B (Ø315)

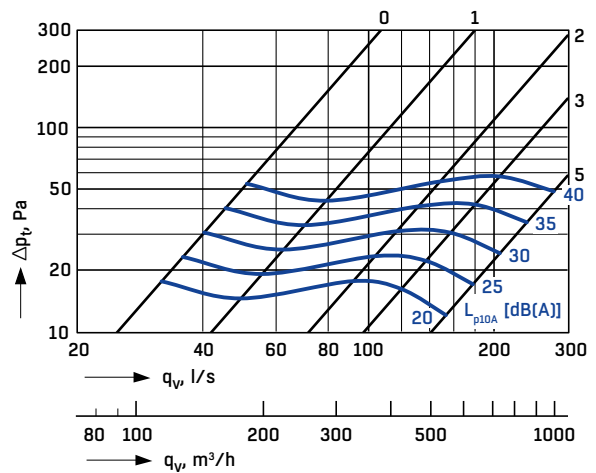

TGE-1000-200-B (Ø315)

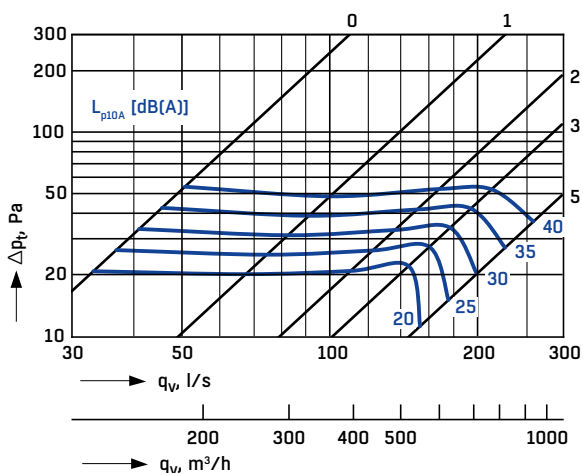

TGE EXHAUST AIR - AIR FLOW, PRESSURE DROP, SOUND LEVEL

C - TOP/BOTTOM CONNECTION

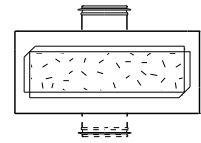

TGE-200-100-C (Ø125)

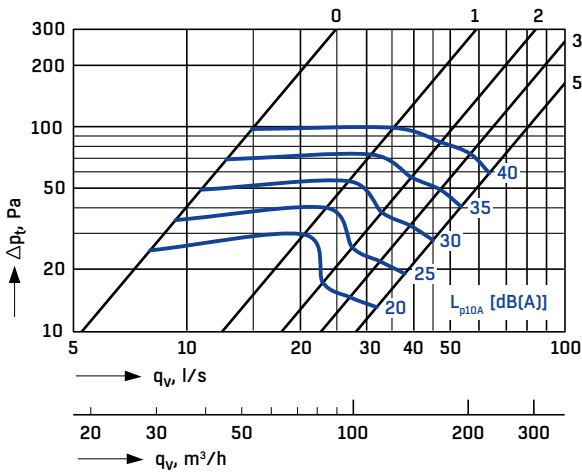

TGE-300-100-C (Ø160)

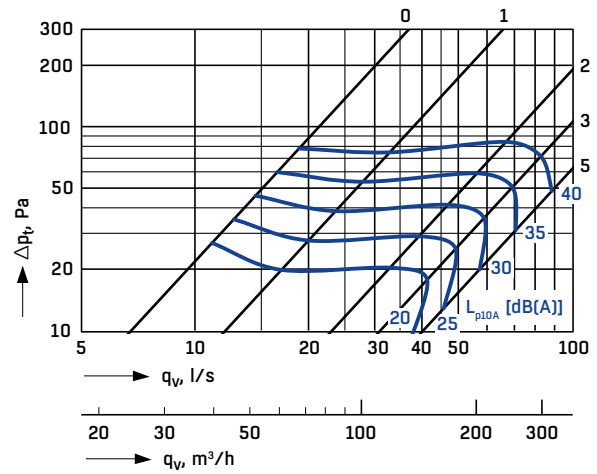

TGE-400-100-C (Ø160)

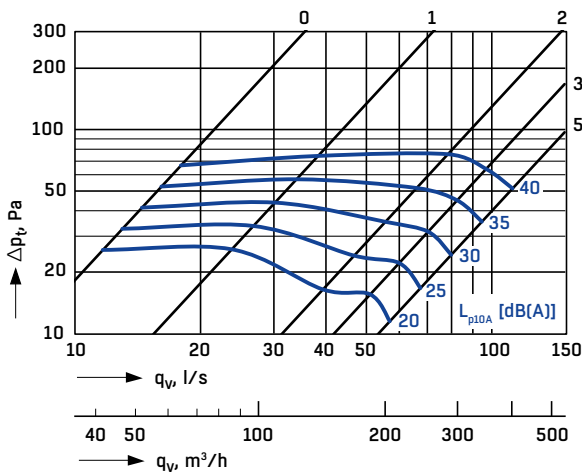

TGE-500-100-C (Ø200)

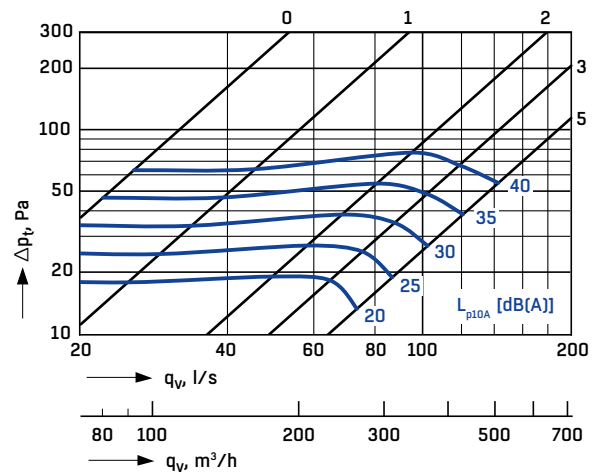

TGE-600-100-C (Ø250)

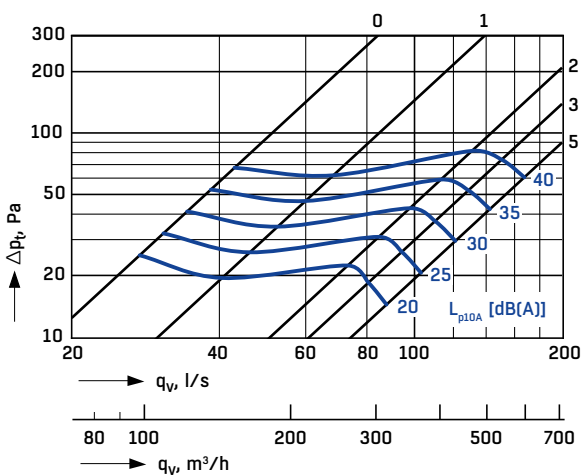

TGE-1000-100-C (Ø250)

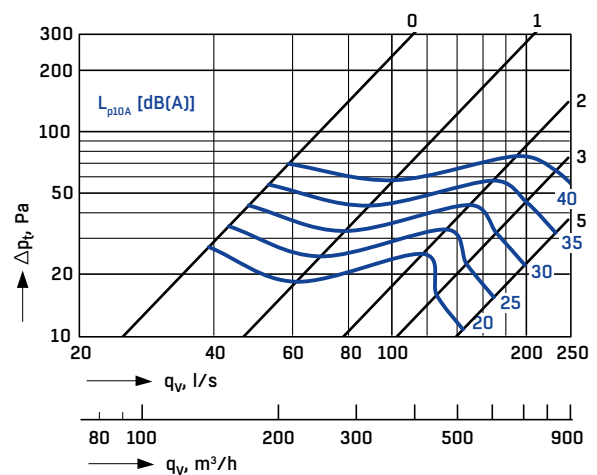

TGE EXHAUST AIR - AIR FLOW, PRESSURE DROP, SOUND LEVEL

C - TOP/BOTTOM CONNECTION

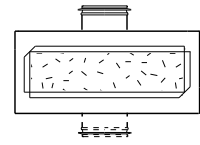

TGE-300-150-C (Ø200)

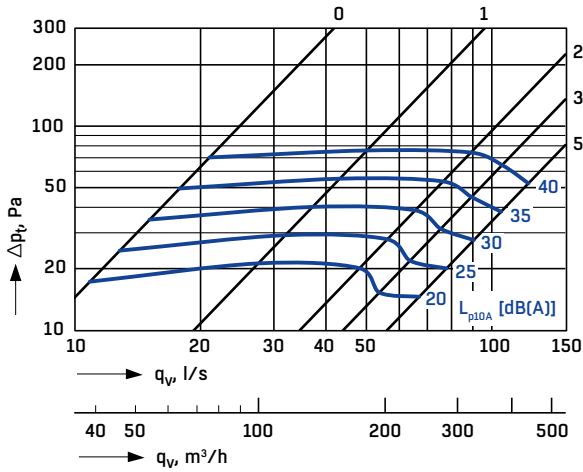

TGE-400-150-C (Ø250)

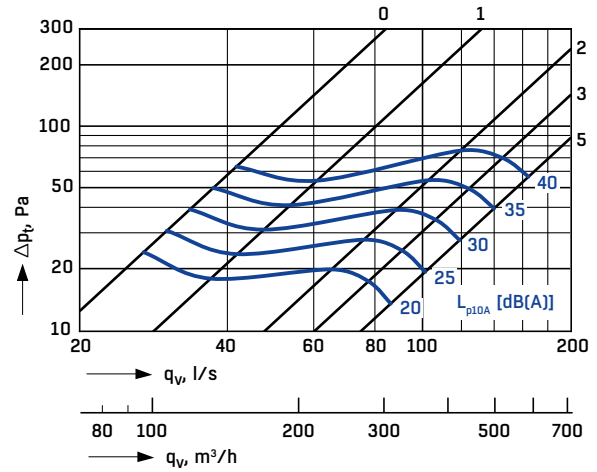

TGE-500-150-C (Ø250)

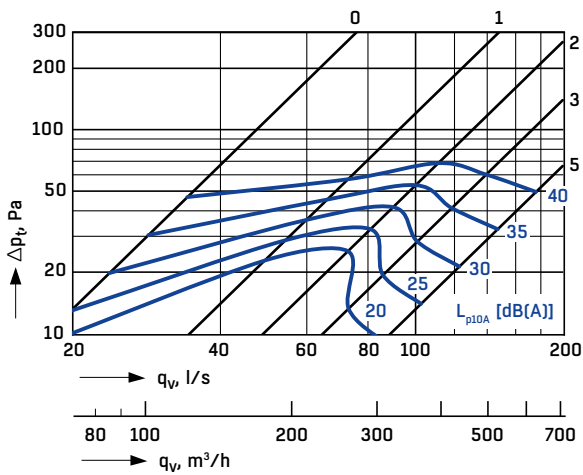

TGE-600-150-C (Ø250)

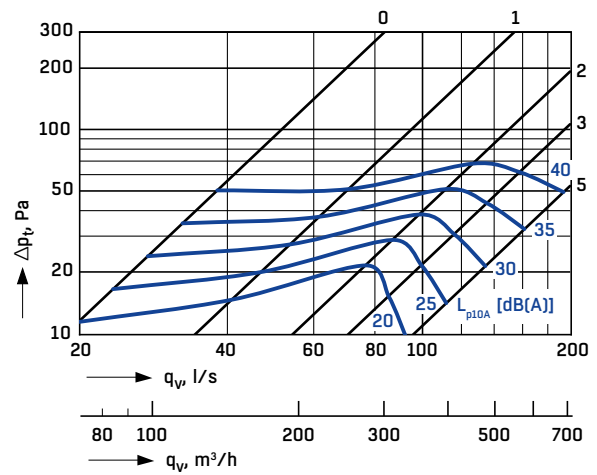

TGE-800-150-C (Ø315)

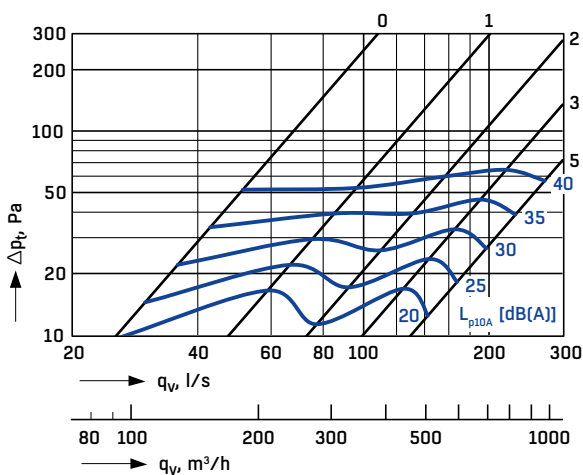

TGE EXHAUST AIR - AIR FLOW, PRESSURE DROP, SOUND LEVEL

C - TOP/BOTTOM CONNECTION

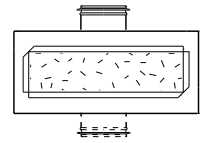

TGE-400-200-C (Ø250)

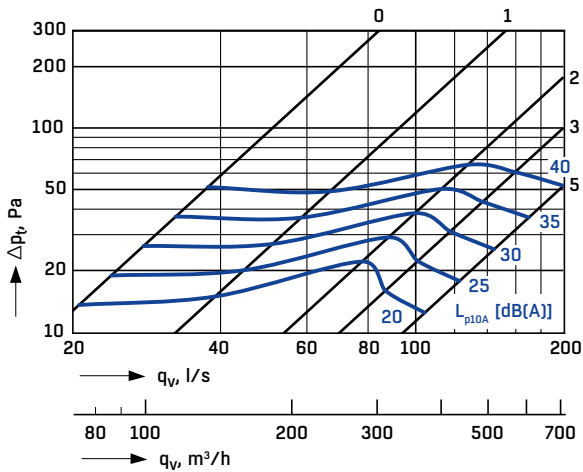

TGE-500-200-C (Ø315)

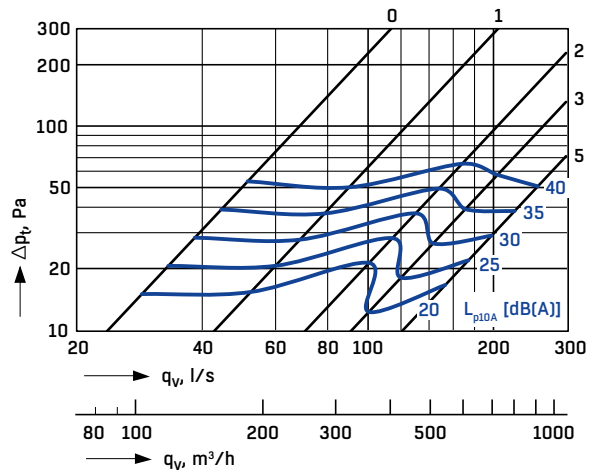

TGE-600-200-C (Ø315)

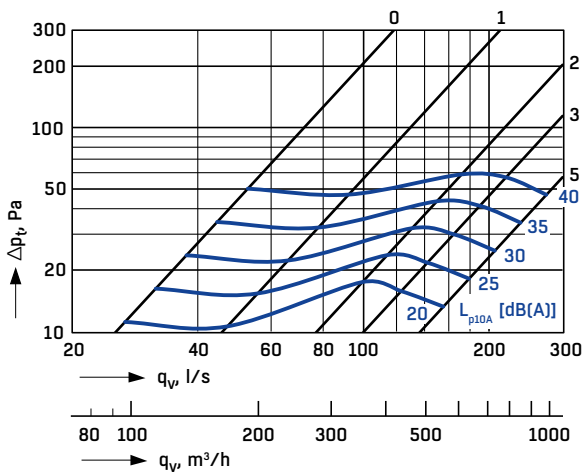

TGE-800-200-C (Ø315)

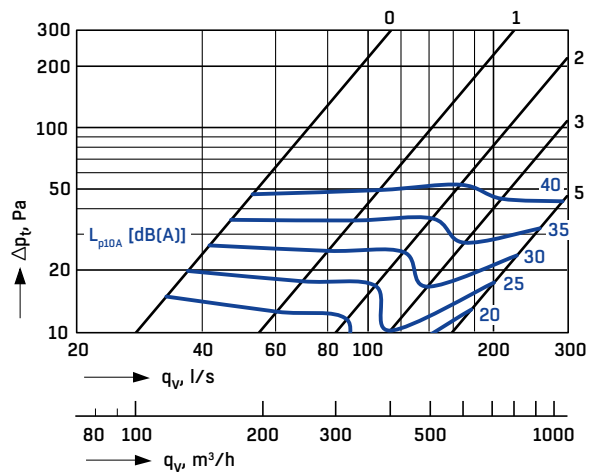

TGE-1000-200-C (Ø315)

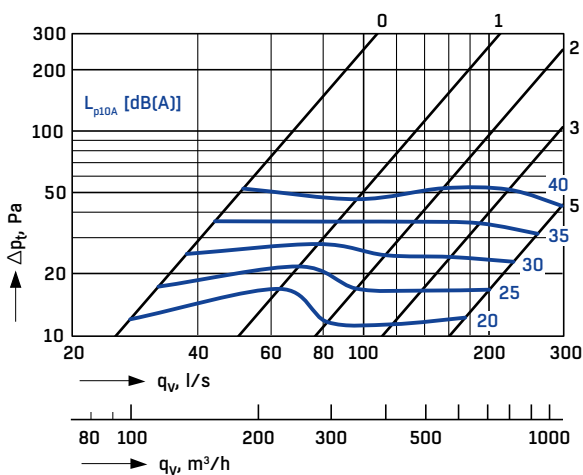

TG SUPPLY AIR - ACOUSTICAL DATA

SOUND POWER LEVEL L_W

TG	Conn. alt.	Correction K_{oct} (dB)						Conn. \emptyset
		Middle frequency of octave band (Hz)						
		125	250	500	1000	2000	4000	
200-100	A	-1	3	0	1	-5	-11	125
	B	1	3	1	1	-5	-12	
	C	2	4	0	1	-6	-14	
300-100	A	2	2	0	1	-6	-11	160
	B	4	2	0	1	-6	-10	
	C	5	3	0	1	-6	-12	
400-100	A	2	2	0	1	-7	-11	160
	B	4	3	0	1	-5	-10	
	C	4	3	0	1	-5	-10	
500-100	A	1	1	0	1	-6	-10	200
	B	3	4	0	0	-5	-10	
	C	4	4	1	1	-7	-13	
600-100	A	3	-1	0	2	-6	-12	250
	B	7	3	1	0	-6	-12	
	C	6	3	0	1	-6	-13	
1000-100	A	2	1	2	1	-7	-14	250
	B	11	6	2	-2	-7	-13	
	C	11	6	1	-2	-6	-12	
300-150	A	2	3	0	1	-5	-10	200
	B	4	2	-1	1	-4	-9	
	C	4	2	-1	1	-4	-11	
400-150	A	2	1	0	1	-6	-14	250
	B	5	2	1	1	-5	-12	
	C	6	2	-1	1	-5	-13	
500-150	A	2	0	1	1	-5	-12	250
	B	6	2	1	0	-6	-11	
	C	5	2	1	1	-5	-12	
600-150	A	2	0	0	1	-5	-12	250
	B	5	2	0	1	-5	-12	
	C	8	4	1	0	-7	-16	
800-150	A	3	0	1	1	-6	-12	315
	B	7	4	1	0	-5	-12	
	C	5	3	0	0	-5	-12	
400-200	A	2	2	0	1	-5	-13	250
	B	5	2	1	0	-5	-12	
	C	6	3	-1	1	-4	-13	
500-200	A	3	1	1	1	-5	-11	315
	B	5	3	2	0	-6	-11	
	C	4	1	0	1	-5	-12	
600-200	A	2	-1	1	1	-5	-12	315
	B	6	3	2	0	-6	-12	
	C	6	2	0	0	-5	-10	
800-200	A	4	-1	1	1	-5	-12	315
	B	4	3	2	1	-8	-15	
	C	6	2	0	1	-5	-12	
1000-200	A	2	-1	1	1	-6	-13	315
	B	6	3	2	0	-6	-13	
	C	6	3	0	1	-5	-12	
Toler. \pm		3	2	2	2	4	5	

Sound power levels for different octave bands are obtained by adding the correction K_{oct} to the sound pressure level L_{p10A} in the design graph according to the following formula:

$$L_W = L_{p10A} + K_{oct}$$

Correction K_{oct} is the mean value in the operating range.

SOUND ATTENUATION ΔL

TG	Conn. alt.	Sound attenuation ΔL (dB)						Conn. \emptyset
		Middle frequency of octave band (Hz)						
		125	250	500	1000	2000	4000	
200-100	A	12	5	16	13	13	10	125
	B	11	5	10	9	8	10	
	C	12	3	15	11	8	9	
300-100	A	11	4	13	13	14	9	160
	B	10	4	8	9	9	9	
	C	10	3	18	12	8	9	
400-100	A	11	4	13	14	13	9	160
	B	10	4	10	11	6	8	
	C	9	3	18	9	6	9	
500-100	A	8	3	13	13	10	12	200
	B	8	3	11	9	11	8	
	C	6	5	19	7	7	10	
600-100	A	9	3	12	12	11	10	250
	B	8	4	10	10	9	7	
	C	8	4	17	8	6	9	
1000-100	A	8	4	11	12	10	9	250
	B	7	6	10	8	7	8	
	C	6	6	14	7	7	8	
300-150	A	10	2	12	11	10	11	200
	B	7	2	6	7	11	7	
	C	7	4	16	9	7	9	
400-150	A	5	5	13	11	11	11	250
	B	4	6	6	8	9	9	
	C	5	7	14	8	7	12	
500-150	A	5	5	12	9	11	10	250
	B	4	6	7	6	9	8	
	C	4	7	16	9	7	13	
600-150	A	4	5	10	11	14	12	250
	B	3	6	8	4	7	7	
	C	5	7	14	7	6	12	
800-150	A	3	6	10	11	10	10	315
	B	4	5	6	6	9	10	
	C	3	11	11	7	8	13	
400-200	A	6	3	11	10	11	10	250
	B	4	5	4	6	9	8	
	C	5	5	13	8	7	12	
500-200	A	4	7	10	10	8	9	315
	B	4	3	7	9	11	10	
	C	3	9	10	7	6	12	
600-200	A	4	6	9	10	9	9	315
	B	3	3	7	6	10	10	
	C	3	8	10	7	7	12	
800-200	A	3	5	9	9	8	9	315
	B	2	3	5	7	9	10	
	C	3	7	10	7	7	13	
1000-200	A	3	6	8	8	9	8	315
	B	2	3	6	6	9	9	
	C	3	7	9	7	7	12	

The average sound attenuation ΔL of the box from duct to room includes the orifice attenuation of the connected duct dimension in a wall installation.

TGE, EXHAUST AIR - ACOUSTICAL DATA

SOUND POWER LEVEL L_W

TGE	Conn. alt.	Correction K_{oct} (dB)						Conn. \varnothing
		Middle frequency of octave band (Hz)						
		125	250	500	1000	2000	4000	
200-100	A	1	4	-2	1	-4	-12	125
	B	-2	1	-1	2	-5	-14	
	C	1	4	-1	0	-3	-11	
300-100	A	0	1	-2	0	-2	-8	160
	B	-1	1	-1	0	-2	-10	
	C	1	2	-1	-2	-1	-10	
400-100	A	1	0	-3	0	-2	-10	160
	B	2	1	-1	0	-2	-11	
	C	2	2	-3	-3	0	-11	
500-100	A	1	-1	-2	0	-2	-9	200
	B	0	-1	-3	-1	0	-11	
	C	0	1	-3	-2	0	-13	
600-100	A	3	-2	-1	-1	-1	-10	250
	B	3	-1	-2	-1	-1	-11	
	C	2	0	-4	-1	-1	-12	
1000-100	A	1	-2	-2	-2	0	-10	250
	B	1	-3	-3	-4	1	-12	
	C	2	-2	-5	-1	0	-12	
300-150	A	0	0	-2	-1	-1	-10	200
	B	-1	0	-1	-2	-1	-10	
	C	2	0	-2	-3	0	-11	
400-150	A	2	-2	-1	0	-1	-10	250
	B	1	-2	0	-2	-1	-9	
	C	1	-1	-3	-1	0	-12	
500-150	A	1	-4	-2	-2	0	-9	250
	B	1	-3	-3	-2	0	-9	
	C	0	-3	-6	-3	1	-13	
600-150	A	2	-3	-2	-1	0	-10	250
	B	4	-1	-2	-1	-1	-9	
	C	2	-3	-6	-3	1	-12	
800-150	A	0	-5	-3	-2	0	-12	315
	B	0	-6	-5	-5	2	-12	
	C	0	-5	-6	-3	1	-12	
400-200	A	2	-3	-3	-2	0	-9	250
	B	0	-3	0	-2	0	-11	
	C	1	-2	-4	-2	1	-11	
500-200	A	1	-5	-3	-2	0	-11	315
	B	-1	-4	-3	-4	1	-11	
	C	1	-4	-5	-3	1	-11	
600-200	A	1	-5	-3	-4	1	-10	315
	B	-1	-5	-4	-4	1	-11	
	C	2	-5	-5	-2	1	-11	
800-200	A	1	-6	-5	-5	2	-11	315
	B	-2	-5	-3	-3	1	-11	
	C	-1	-7	-6	-3	1	-13	
1000-200	A	-1	-4	-3	-3	1	-10	315
	B	-1	-8	-5	-2	1	-11	
	C	-2	-8	-8	-4	2	-13	
Toler. \pm		3	2	2	2	4	5	

Sound power levels for different octave bands are obtained by adding the correction K_{oct} to the sound pressure level L_{p10A} in the design graph according to the following formula:

$$L_W = L_{p10A} + K_{oct}$$

Correction K_{oct} is the mean value in the operating range.

SOUND ATTENUATION ΔL

TGE	Conn. alt.	Sound attenuation ΔL (dB)						Conn. \varnothing
		Middle frequency of octave band (Hz)						
		125	250	500	1000	2000	4000	
200-100	A	12	5	16	13	13	10	125
	B	11	5	10	9	8	10	
	C	12	3	15	11	8	9	
300-100	A	11	4	13	13	14	9	160
	B	10	4	8	9	9	9	
	C	10	3	18	12	8	9	
400-100	A	11	4	13	14	13	9	160
	B	10	4	10	11	6	8	
	C	9	3	18	9	6	9	
500-100	A	8	3	13	13	10	12	200
	B	8	3	11	9	11	8	
	C	6	5	19	7	7	10	
600-100	A	6	4	10	12	11	10	250
	B	7	3	10	8	10	9	
	C	7	4	16	9	8	9	
1000-100	A	6	4	12	12	9	11	250
	B	8	3	10	8	9	9	
	C	8	4	13	11	8	7	
300-150	A	10	2	12	11	10	11	200
	B	7	2	6	7	11	7	
	C	7	4	16	9	7	9	
400-150	A	5	5	13	11	11	11	250
	B	4	6	6	8	9	9	
	C	5	7	14	8	7	12	
500-150	A	5	5	12	9	11	10	250
	B	4	6	7	6	9	8	
	C	4	7	16	9	7	13	
600-150	A	4	5	10	11	14	12	250
	B	3	6	8	4	7	7	
	C	5	7	14	7	6	12	
800-150	A	3	6	10	11	10	10	315
	B	4	5	6	6	9	10	
	C	3	11	11	7	8	13	
400-200	A	6	3	11	10	11	10	250
	B	4	5	4	6	9	8	
	C	5	5	13	8	7	12	
500-200	A	4	7	10	10	8	9	315
	B	4	3	7	9	11	10	
	C	3	9	10	7	6	12	
600-200	A	4	6	9	10	9	9	315
	B	3	3	7	6	10	10	
	C	3	8	10	7	7	12	
800-200	A	3	5	9	9	8	9	315
	B	2	3	5	7	9	10	
	C	3	7	10	7	7	13	
1000-200	A	4	4	8	10	7	10	315
	B	3	4	4	6	8	11	
	C	4	7	8	9	6	11	

The average sound attenuation ΔL of the box from duct to room includes the orifice attenuation of the connected duct dimension in a wall installation.

DIMENSIONS

PLENUM BOX TG/TGE

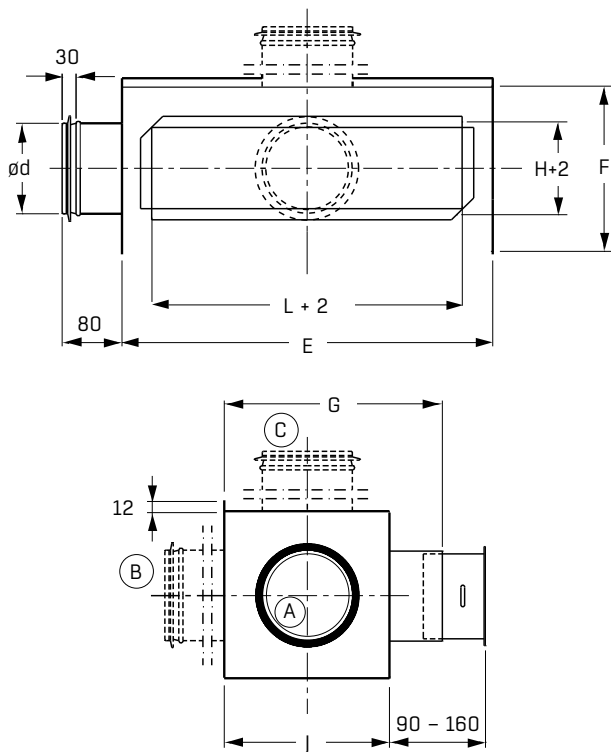

Size (width - height)	$\varnothing d$ (mm)	E (mm)	F (mm)	G (mm)	J (mm)
200-100	124	260	170	270	180
300-100	156	360	220	295	205
400-100	156	460	220	295	205
500-100	199	560	245	335	245
600-100	249	660	297	395	305
1000-100	249	1060	297	395	305
300-150	199	360	245	335	245
400-150	249	460	297	395	305
500-150	249	560	297	395	305
600-150	249	660	297	395	305
800-150	314	860	380	470	380
400-200	249	460	297	395	305
500-200	314	560	380	470	380
600-200	314	660	380	470	380
800-200	314	860	380	470	380
1000-200	314	1060	380	470	380

GENERAL

EXECUTION AND FUNCTION

Plenum boxes TG (supply air) and TGE (exhaust air) are intended for rectangular grilles and have a circular duct connection. The plenum box can be connected from the side, the top or the back. The boxes have a low sound level and a good sound attenuation capacity. The TG includes an easily removable balancing plate which gives a uniform air flow to the grilles.

The patented multipoint measuring of the measurement and adjustment damper enables balanced and accurate values. The adjustment handle of the measurement and adjustment damper has a position indicator and a locking device. For minor damper openings (0–1) the measurement and adjustment damper features a finetuning function that is operated by turning the adjustment spindle of the adjustment handle. With larger openings (1–5), the sliding adjustment provides fast settings. The setting is locked by turning the adjustment spindle clockwise to the locking position. The measurement and adjustment damper can be easily removed for inspection and cleaning without changing its setting. The k-factors for different installations (supply air) are marked on the adjusting cable. For k-factors for exhaust air, see the separate adjustment instructions.

INSTALLATION

The plenum box has a circular duct connection and rectangular connection for grilles. For more detailed information, see the product-specific installation instructions.

MAINTENANCE

The TG/TGE plenum boxes include a measurement and adjustment damper (ZAEF) that can be easily removed without changing its setting. For more detailed information, see the product-specific maintenance instructions. The ductwork can be cleaned through the box.

MATERIAL

Made of galvanized sheet steel. The sound attenuation elements are made of polyester fiber. The measurement and adjustment damper is mainly plastic (ABS and PA).

PRODUCT DESCRIPTION

TG/TGE plenum box by FläktGroup, for supply/exhaust air. The plenum box includes a removable ZAEF measurement and adjustment damper.

PRODUCT CODE AND ACCESSORIES

PRODUCT CODE

Plenum box, supply air
Plenum box, exhaust air

TG-aaaa-bbb-c
TGE-aaaa-bbb-c

Length of grille connection (L), mm (aaaa)
Height of grille connection (H), mm (bbb)

Connection alternative (c)

A = from the side (short side)
B = from the rear
C = from above / from below

ACCESSORIES

Measurement and adjustment damper

ZAEF-aaa-b

Size, mm (aaa)

100, 125, 160, 200, 250, 315

Hose length, m (b)

1 = 1 m
3 = 2 m

EXCELLENCE IN SOLUTIONS

FläktGroup is the European market leader for smart and energy efficient Indoor Air and Critical Air solutions to support every application area. We offer our customers innovative technologies, high quality and outstanding performance supported by more than a century of accumulated industry experience. The widest product range in the market, and strong market presence in 65 countries worldwide, guarantee that we are always by your side, ready to deliver Excellence in Solutions.

PRODUCT FUNCTIONS BY FLÄKTGROUP

Air Treatment | Air Movement | Air Diffusion | Air Distribution | Air Filtration
Air Management & ATD's | Air Conditioning & Heating | Controls | Service

» Learn more on www.flaktgroup.com
or contact one of our offices